

Preface

About SunFounder

SunFounder is a technology company focused on Raspberry Pi and Arduino open source community development. Committed to the promotion of open source culture, we strive to bring the fun of electronics making to people all around the world and enable everyone to be a maker. Our products include learning kits, development boards, robots, sensor modules and development tools. In addition to high quality products, SunFounder also offers video tutorials to help you build your own project. If you have interest in open source or making something cool, welcome to join us! Visit www.sunfounder.com for more!

About Sensor Kit V1.0

This kit is suitable for SunFounder Uno, SunFounder Mega 2560, SunFounder Duemilanove and SunFounder Nano. All the code in this user manual is compatible with these boards.

Our SunFounder board is fully compatible with Arduino board.

You can go to our official website www.sunfounder.com to download related code by clicking **LEARN** -> **Get Tutorials**. If you have any questions, please send an email to support@sunfounder.com. Also welcome to leave a message and share your projects on our **FORUM**.

Note: This kit is different from other kits. All the components in this kit are provided in the form of modules which integrate some necessary components, such as comparator, resistor, and capacitor and so on. Therefore it is convenient for circuit connection.

Contents

Components List	1
Notice.....	8
Lesson 1 Hall Sensor	10
Lesson 2 RGB LED	15
Lesson 3 Dual-color Common-Cathode LED.....	18
Lesson 4 Shock Switch.....	20
Lesson 5 Knock Sensor	22
Lesson 6 Infrared Transmitter	24
Lesson 7 Laser Transmitter.....	26
Lesson 8 Reed Switch	28
Lesson 9 Infrared-Receiver	31
Lesson 10 Analog Temperature Sensor.....	33
Lesson 11 Digital Temperature Sensor	35
Lesson 12 Buzzer.....	37
Lesson 13 Button Switch.....	40
Lesson 14 Photo-interrupter.....	42
Lesson 15 Tilt-Switch.....	44
Lesson 16 Mercury Switch.....	46
Lesson 17 Magic Cup.....	48
Lesson 18 DS18B20 Temperature Sensor.....	50
Lesson 19 Rotary Encoder	52
Lesson 20 7-Color Auto-flash LED.....	55
Lesson 21 Photoresistor Sensor	56
Lesson 22 Humiture Sensor.....	58
Lesson 23 Obstacle Avoidance Sensor	60
Lesson 24 Tracking Sensor.....	62
Lesson 25 Microphone Sensor.....	64
Lesson 26 Metal Touch Sensor	67

Lesson 27 Flame Sensor.....	69
Lesson 28 Relay Module	71
Lesson 29 Joystick PS2	73
Lesson 30 MQ-2 Gas Sensor.....	75
Lesson 31 Password Lock.....	77
Lesson 32 Lie Detector	79
Lesson 33 Fire Alarm	81
Lesson 34 Thermostatic Water Tank System.....	83
Lesson 35 Intelligent Environment Monitoring.....	85



SunFoundry

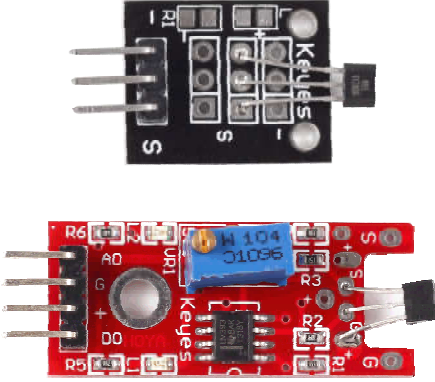
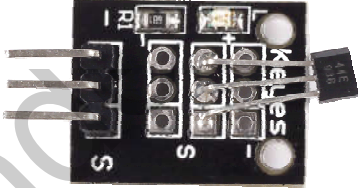
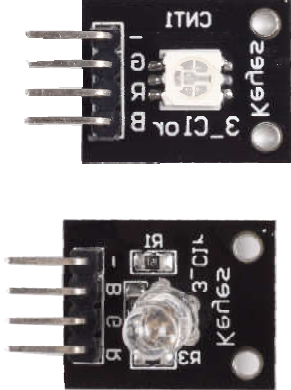
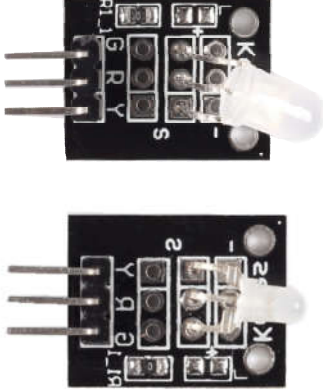

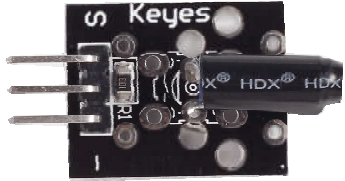
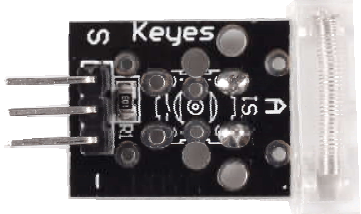
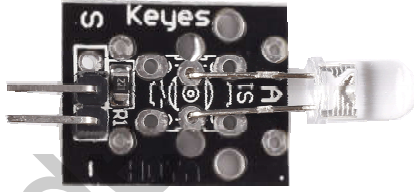
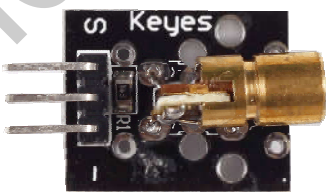
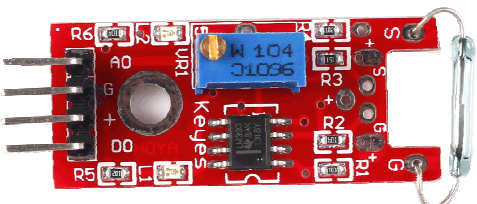
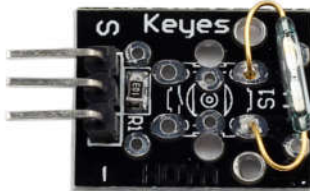
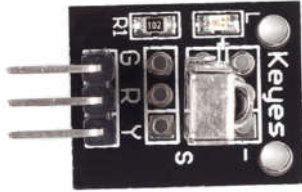
Components List

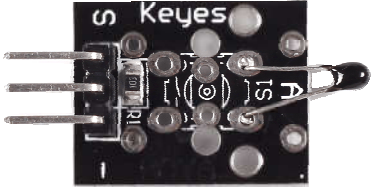
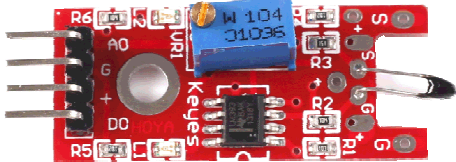
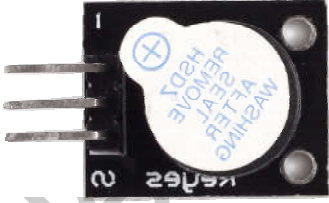
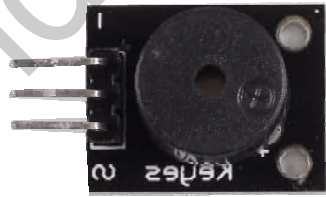
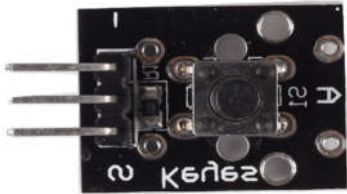
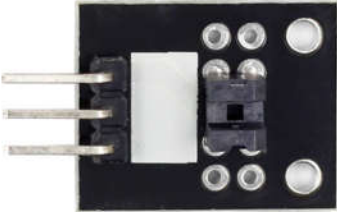
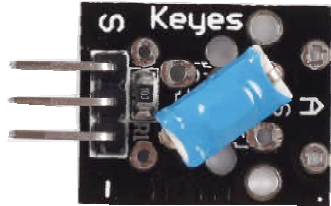
No.	Name	Qty.	Component
1	Analog Hall Sensor	2	
2	Switch Hall Sensor	1	
3	RGB LED	2	
4	Dual-color Common-Cathode LED	2	

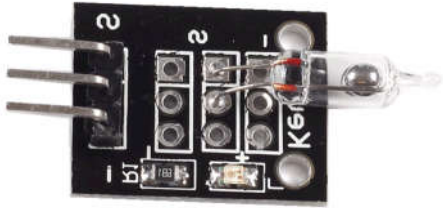
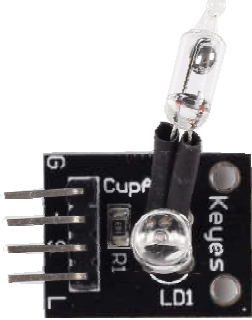
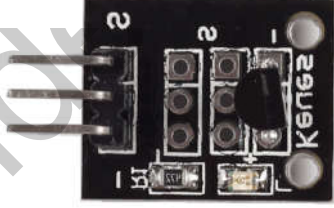
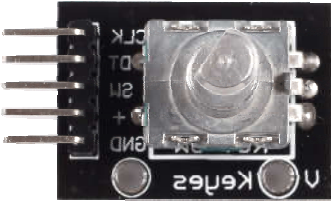
5	Shock Switch	1	 <p>A black PCB module labeled '5 Keyes' with three pins on the left and a black cylindrical sensor component in the center.</p>
6	Knock Sensor	1	 <p>A black PCB module labeled '5 Keyes' with three pins on the left and a clear cylindrical sensor component on the right.</p>
7	Infrared Transmitter	1	 <p>A black PCB module labeled '5 Keyes' with three pins on the left and a clear infrared LED component on the right.</p>
8	Laser Transmitter	1	 <p>A black PCB module labeled '5 Keyes' with three pins on the left and a gold-colored laser diode component in the center.</p>
9	Reed Switch	1	 <p>A red PCB module labeled 'Keyes' with three pins on the left, a reed switch component in the center, and various electronic components like resistors and capacitors.</p>
10	Mini Reed	1	 <p>A black PCB module labeled '5 Keyes' with three pins on the left and a small reed switch component on the right.</p>
11	Infrared Receiver	1	 <p>A black PCB module labeled 'Keyes' with three pins on the left and an infrared receiver component in the center.</p>

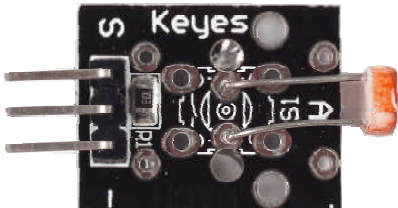
12	Analog Temperature Sensor	1	 <p>Analog Temperature Sensor module on a black PCB with three pins and a silver sensor element.</p>
13	Digital Temperature Sensor	1	 <p>Digital Temperature Sensor module on a red PCB with three pins, a blue capacitor, and a silver sensor element.</p>
14	Active Buzzer	1	 <p>Active Buzzer module on a black PCB with three pins and a white circular buzzer component.</p>
15	Passive Buzzer	1	 <p>Passive Buzzer module on a black PCB with three pins and a black circular buzzer component.</p>
16	Button Switch	1	 <p>Button Switch module on a black PCB with three pins and a square push-button.</p>
17	Photo-interrupter	1	 <p>Photo-interrupter module on a black PCB with three pins and a white sensor window.</p>
18	Tilt Switch	1	 <p>Tilt Switch module on a black PCB with three pins and a blue capacitor.</p>

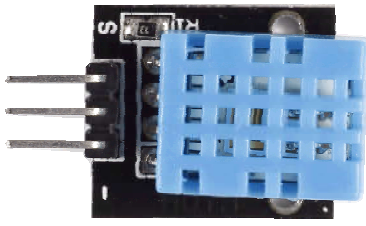
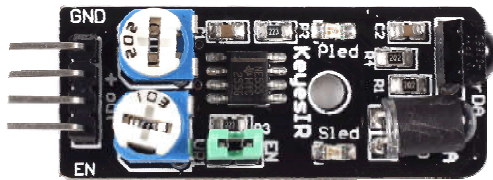
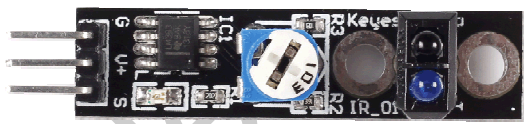
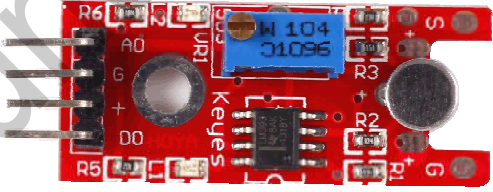
19	Mercury Switch	1	 <p>A black PCB module with a 5-pin header on the left. It features a central mercury switch, a 10kΩ pull-up resistor, and a 100nF capacitor. Labels include 'S', '2', '10k', '100n', and 'Keyes'.</p>
20	Magic Cup	2	 <p>A black PCB module with a 5-pin header on the left. It features a small cup-shaped sensor and a 100nF capacitor. Labels include 'G', 'Cup', '100n', 'L', and 'Keyes'.</p>
21	DS18B20 Temperature Sensor	1	 <p>A black PCB module with a 3-pin header on the left. It features a DS18B20 temperature sensor and a 10kΩ pull-up resistor. Labels include 'S', '2', '10k', '100n', and 'Keyes'.</p>
22	Rotary Encoder	1	 <p>A black PCB module with a 5-pin header on the left. It features a rotary encoder and a 10kΩ pull-up resistor. Labels include 'CLK', 'D1', 'D2', 'S+', 'GND', and 'Keyes'.</p>
23	7-color Auto-flash LED	1	 <p>A black PCB module with a 5-pin header on the left. It features a 7-color auto-flash LED and a 10kΩ pull-up resistor. Labels include 'S', 'Keyes', '10k', '100n', and 'A'.</p>
24	Photoresistor Sensor	1	 <p>A black PCB module with a 5-pin header on the left. It features a photoresistor sensor and a 10kΩ pull-up resistor. Labels include 'S', 'Keyes', '10k', '100n', and 'A'.</p>

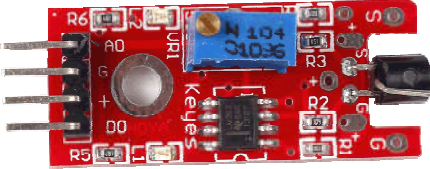
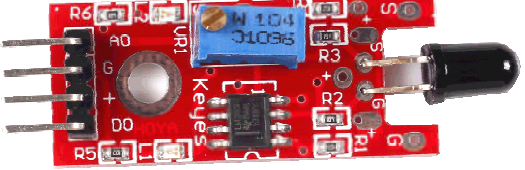
25	Humiture Sensor	1	 <p>A black PCB sensor module with a blue 4-pin header. It features a small black sensor component and a blue potentiometer.</p>
26	Obstacle Avoidance Sensor	1	 <p>A black PCB module with two blue potentiometers, a black sensor, and a 4-pin header. Labels include GND, EN, and IR.</p>
27	Tracking Sensor	1	 <p>A black PCB module with a blue potentiometer, a black sensor, and a 4-pin header. Labels include GND, EN, and IR.</p>
28	Microphone Sensor	1	 <p>A red PCB module with a blue potentiometer, a microphone, and a 4-pin header. Labels include A0, G, DO, and Keys.</p>
29	High-sensitive Voice Sensor	1	 <p>A red PCB module with a blue potentiometer, a microphone, and a 4-pin header. Labels include A0, G, DO, and Keys.</p>
30	Metal Touch Sensor	1	 <p>A red PCB module with a blue potentiometer, a touch sensor, and a 4-pin header. Labels include A0, G, DO, and Keys.</p>
31	Flame Sensor	1	 <p>A red PCB module with a blue potentiometer, a flame sensor, and a 4-pin header. Labels include A0, G, DO, and Keys.</p>

32	Relay Module	1	 <p>A blue PCB relay module with a single relay, labeled 'Keyes_SRLy'. It features a 5-pin header on the left and screw terminals on the right. The relay is marked 'SMD-05VDC-SL-C' and '10A 250VAC 10A 250VDC'.</p>
33	Joystick PS2	1	 <p>A black PCB joystick module labeled 'Keyes_Stoysr'. It includes a PS2 joystick connector, a 5-pin header, and a black joystick cap. The PCB has labels for 'GND', 'V+', 'V-', 'R+', and 'R-'.</p>
34	MQ-2 Gas Sensor	1	 <p>A red PCB gas sensor module labeled 'MQ-2 Gas Sensor'. It features a circular metal mesh sensor, a 5-pin header, and a blue potentiometer. Labels include 'GND', 'V+', 'A+', and 'A-'.</p>
35	LCD1602	1	 <p>A green PCB LCD1602 module with a blue LCD screen and a 16-pin header. The PCB is labeled 'LCD1602'.</p>
36	4x4 Keypad	1	 <p>A black 4x4 keypad module with a white ribbon cable. The keypad has buttons for numbers 1-9, 0, *, #, and letters A, B, C, D. Labels include 'V+', 'V-', 'R+', and 'R-'.</p>
37	Remote Control	1	 <p>A white remote control with a black border. It features a numeric keypad (0-9), function buttons like 'EQ', 'Mode', 'USB', and 'M+', and a power button. The text 'SPECIAL FOR MP3' is visible on the left side.</p>

38	250k Ohm Potentiometer	1	
39	470k Ohm Resistor	1	
40	Breadboard	1	
41	Jumper Wire (M to F)	40	
42	Jumper Wire (M to M)	20	

Notice

All the experiments in this kit are done with SunFounder Uno R3 board, but they are also compatible with SunFounder Mega 2560, SunFounder Nano and all official Arduino Boards. All the code included in this kit works with these boards.

So what does COMPATIBLE mean here? It means you can use any of the three boards to do the same experiment with the same wiring. Take turning on an LED as an example. We use SunFounder Uno as the microcontroller, but you can also use SunFounder Nano or SunFounder Mega 2560 to serve the same function. Just select the right Board and COM when compiling.

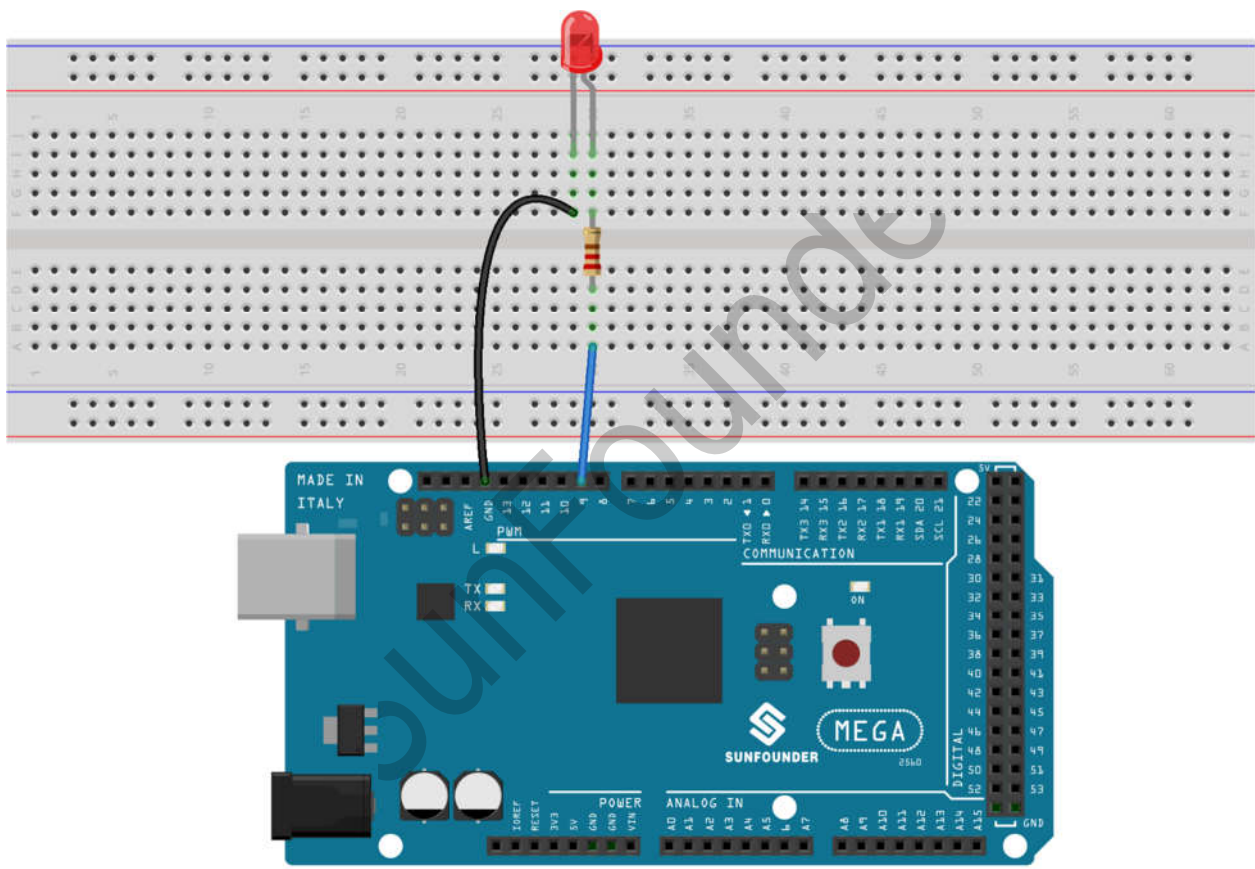

fritzing

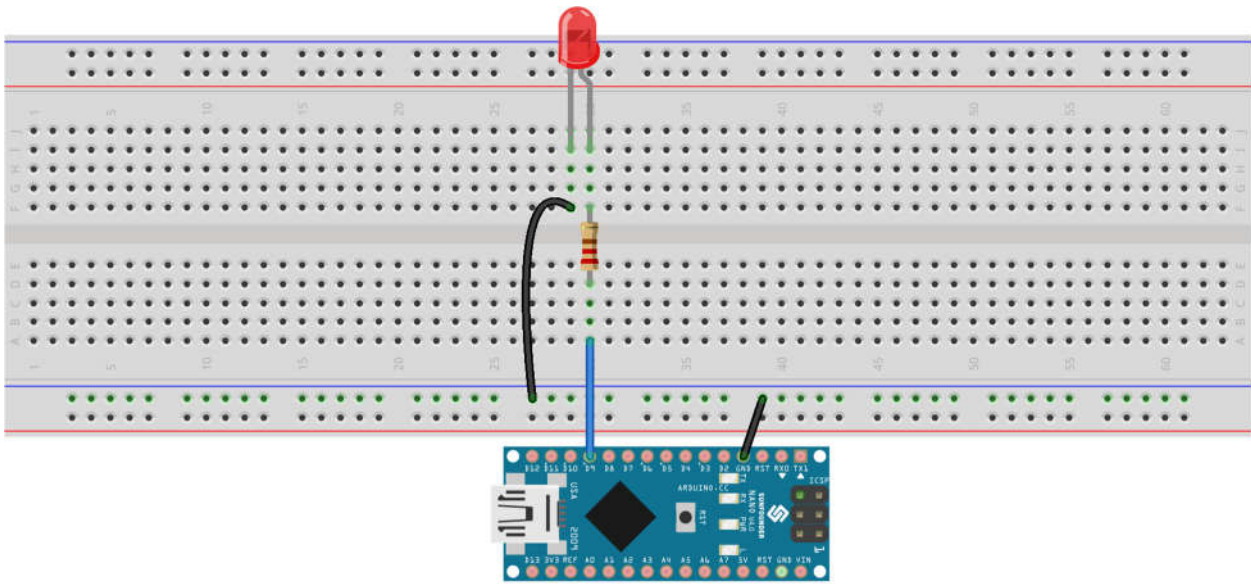

fritzing



SunFounder Mega 2560 R3



SunFounder Uno R3

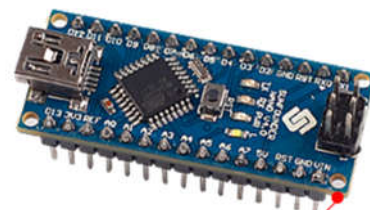

SunFounder Nano

Lesson 1 Hall Sensor

Introduction

Based on the Hall Effect, a hall sensor is one that varies its output voltage in response to a magnetic field. Hall sensors are used for proximity switching, positioning, speed detection, and current sensing applications.

Hall sensors can be categorized into linear (analog) Hall sensors and switch Hall sensors. A switch Hall sensor consists of voltage regulator, Hall element, differential amplifier, Schmitt trigger, and output terminal and it outputs digital values. A linear Hall sensor consists of a Hall element, linear amplifier, and emitter follower and it outputs analog values.

There are three types of hall sensor module in this kit (as shown below): linear Hall sensor (in two forms) which outputs analog signals, and switch Hall sensor which outputs digital signals. If you add a comparator to the linear Hall sensor, it will be able to output both analog and digital signals.

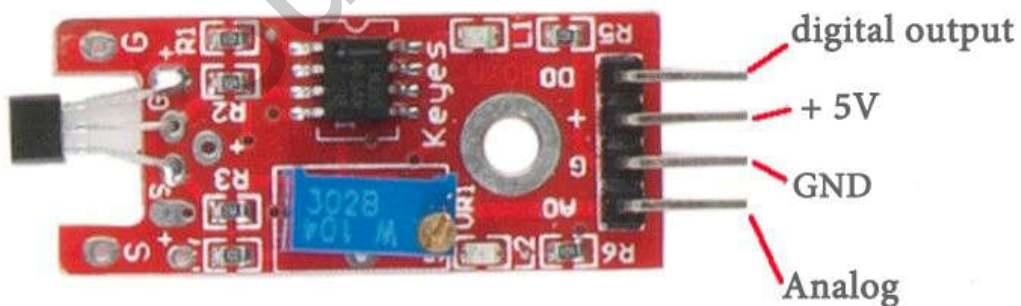

Linear Hall

Components

- 1 * SunFounder Uno board
- 1 * USB data cable
- 1 * Hall sensor module
- 1 * LCD1602
- 1 * Potentiometer
- Several jumper wires

Experimental Principles

Hall Effect

Hall Effect is a kind of electromagnetic effect. It was discovered by Edwin Hall in 1879 when he was researching conductive mechanism about metals. The effect is seen when a conductor is passed through a uniform magnetic field. The natural electron drift of the charge carriers causes the magnetic field to apply a Lorentz force (the force exerted on a charged particle in an electromagnetic field) to these charge carriers. The result is what is seen as a charge separation, with a buildup of either positive or negative charges on the bottom or on the top of the plate.

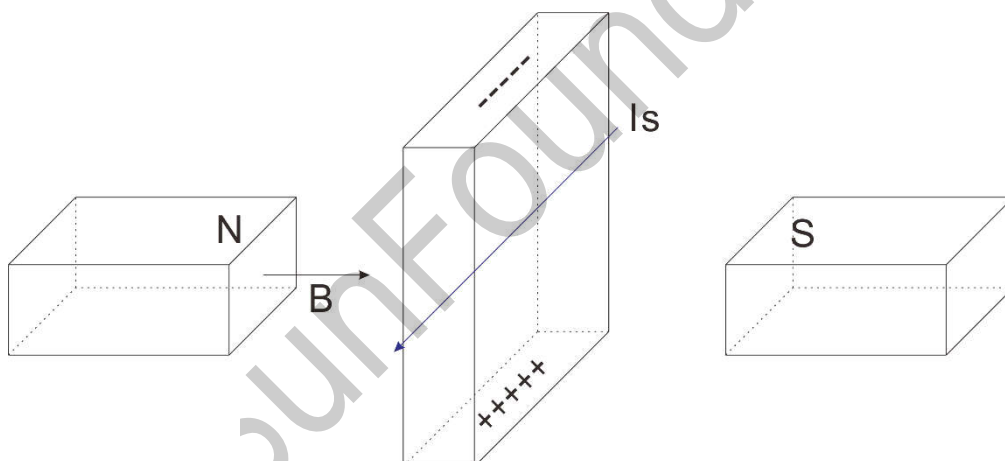

Hall Sensor

A hall sensor is a kind of magnetic field sensor based on the effect.

Electricity carried through a conductor will produce a magnetic field that varies with current, and a Hall sensor can be used to measure the current without interrupting the circuit. Typically, the sensor is integrated with a wound core or permanent magnet that surrounds the conductor to be measured.

Experimental Procedures

For **linear Hall sensor module**, please take the following steps.

Step 1: Build the circuit

Linear Hall Sensor Module	SunFounder Uno
S -----	A5
- -----	GND
+ -----	5V

Step 2: Program (Please refer to the example code in [LEARN -> Get Tutorial](#) on our [website](#))

Step 3: Compile

Step 4: Upload the sketch to SunFounder Uno

Now, you can see the LED attached to pin 13 on SunFounder Uno board blinking. If a magnet approaches the linear Hall sensor, the blinking frequency of LED will increase or decrease.



For **Switch Hall Sensor module**

Step 1: Build the circuit

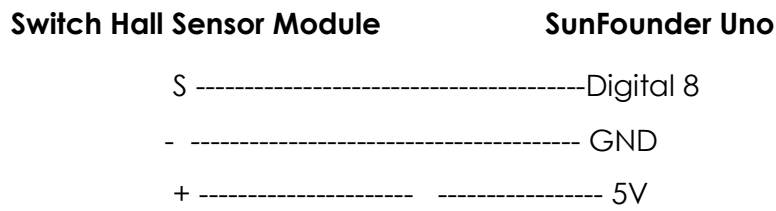

Step 2: Program (Please refer to the example code in [LEARN -> Get Tutorial](#) on our [website](#))

Step 3: Compile

Step 4: Upload the sketch to SunFounder Uno

Now, place a magnet close to the switch Hall sensor. Then the indicator LED on the switch Hall sensor will light up and the buzzer will beep. At the same time, the LED attached to pin 13 on the SunFounder Uno board will light up.

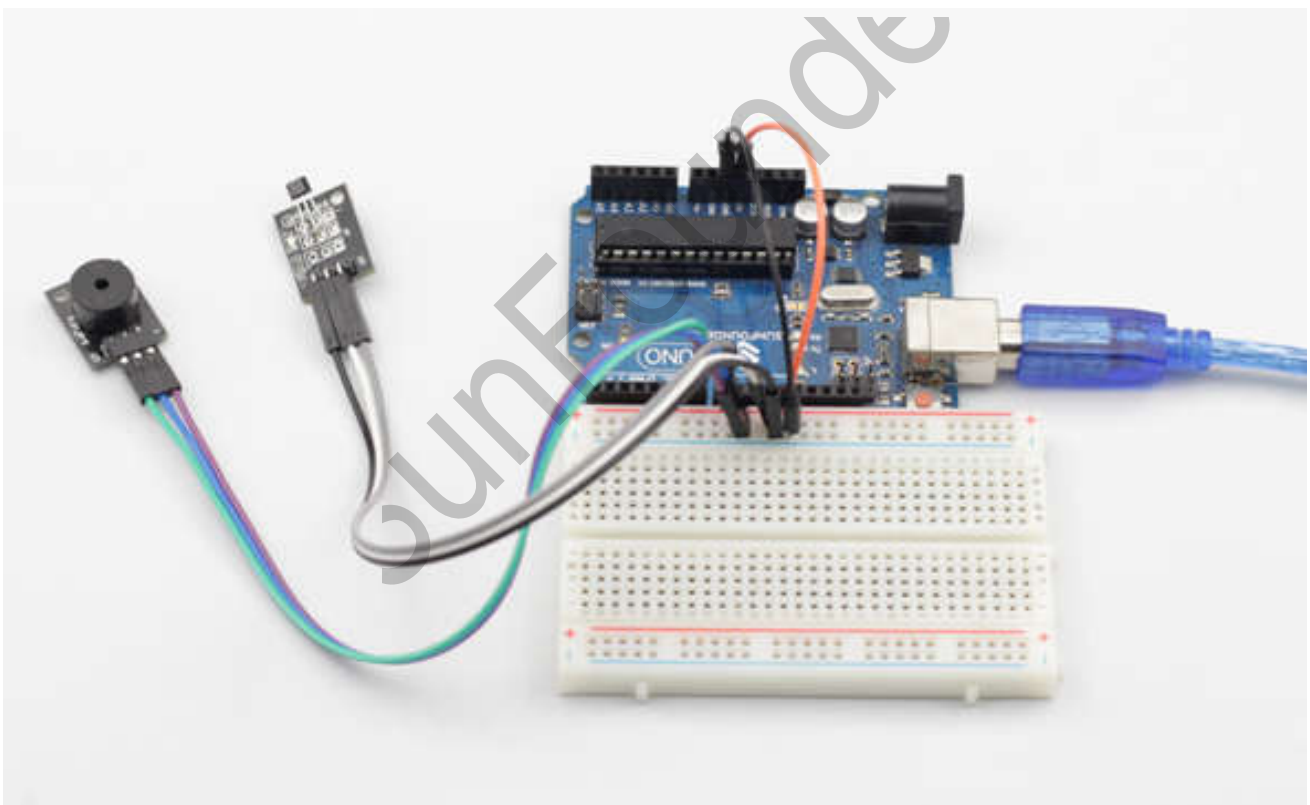

For **linear Hall sensor module (with a comparator added)**

Step 1: Build the circuit

Linear Hall Sensor Module	SunFounder Uno
AO -----	A0
DO -----	Digital 8
- -----	GND
+ -----	5V

LCD1602 connection: connect pin RS to digital pin 3; R/W to GND; E to digital pin 4; D4~D7 to digital pin 9 to 12; VSS to GND; VDD to 5V; A to 3.3V; K to GND

Potentiometer connection: Connect its middle pin to VO of LCD1602 and any other pin to GND

Step 2: Program (Please refer to the example code in [LEARN -> Get Tutorial](#) on our [website](#))

Step 3: Compile

Step 4: Upload the sketch to SunFounder Uno

Now, put a magnet close to the linear Hall sensor, and the indicator LED on the linear Hall sensor will light up. At the same time, the analog and digital value displayed on the LCD will change accordingly.

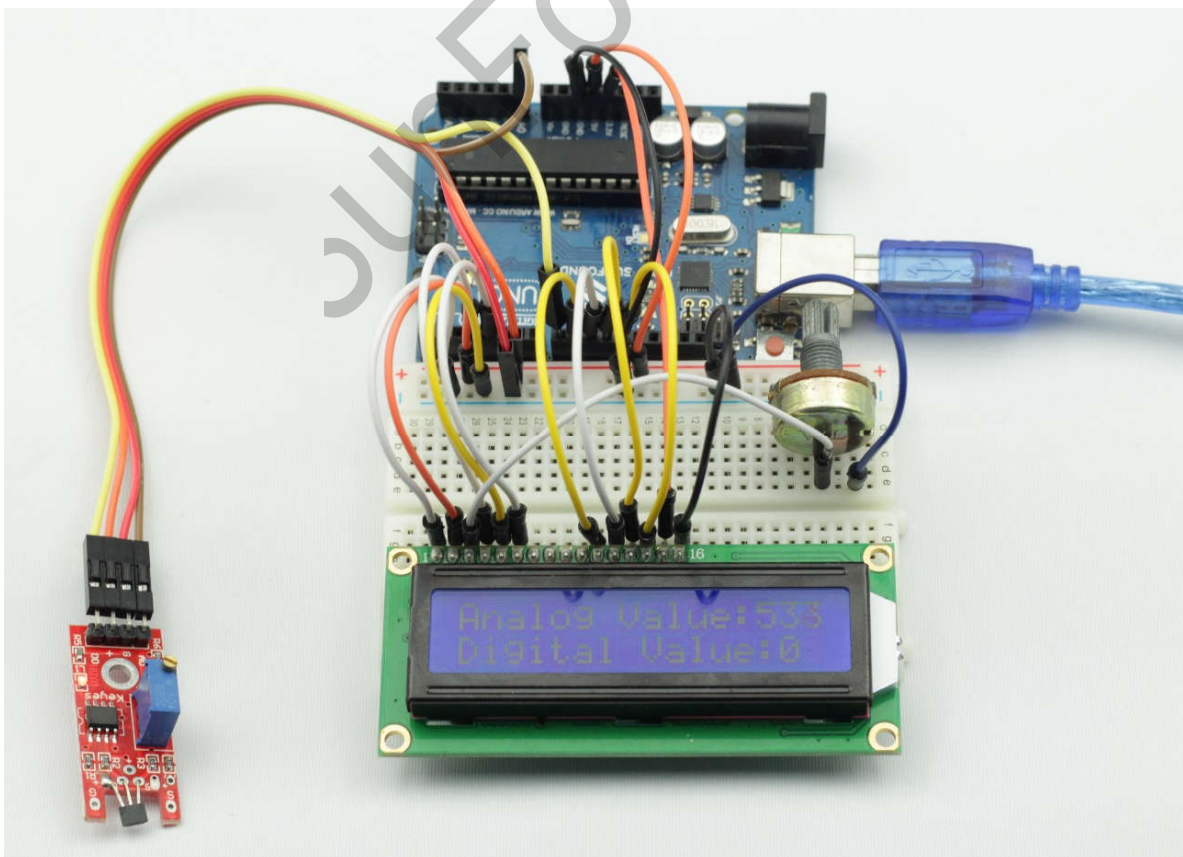

Lesson 2 RGB LED

Introduction

There are two kinds of packages for RGB LED (as shown below) in this kit. One is Surface Mount Device (SMD) type, and the other is Dual In-line Package (DIP) type.

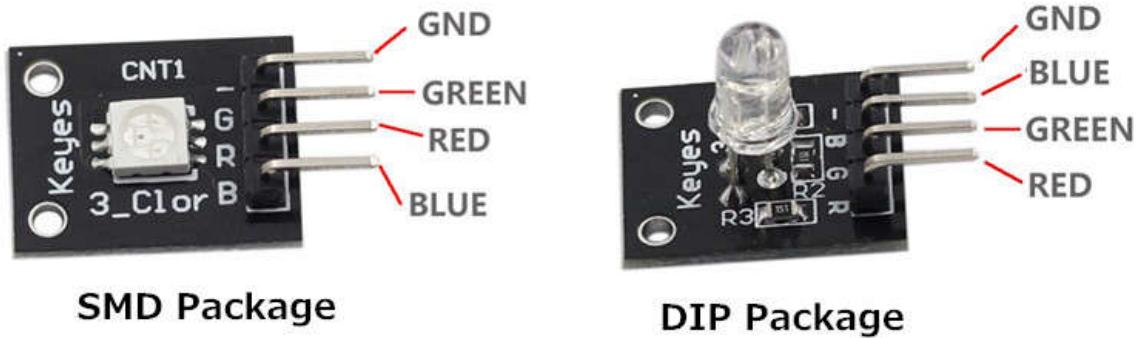

Components

- 1 * SunFounder Uno board
- 1 * USB data cable
- 1 * RGB LED module
- Several jumper wires

Experimental Principle

RGB LED modules can emit various colors of light. Three LEDs of red, green, and blue are packaged into a transparent or semitransparent plastic shell with four pins led out. The three primary colors, red, green, and blue, can be mixed into various kinds of color by brightness, so you can make an RGB LED emit colorful light by controlling the circuit.

In this experiment, we will also use PWM technology to control the brightness of RGB.

Before we talk about PWM, let's take a look at the applications of PWM first. PWM has been successfully applied in motor speed regulation, steering angle control, light intensity control and signal output. For example, when PWM is applied to a horn, it will make sounds. After we know about its special functions, let's find out what PWM really is.

Pulse Width Modulation commonly refers to PWM. Pulse Width Modulation (PWM) is a digital coding method for analog signal levels. Since a computer cannot output an analog voltage but digital voltage value 0V or 5V, we modulate the duty cycle of square waves to encode a specific level of analog signal by using a high-resolution counter. PWM signals are essentially digital signals, for the full amplitude DC power supply is either 5V (ON) or 0V (OFF)

at any given time. Voltage or current source is applied to an analog load in the form of ON or OFF repetitive pulse sequence. When it is on, DC power supply will be applied to the load; when it is off, DC power supply will be disconnected. If only the bandwidth is wide enough, any analog value can be encoded by PWM. The output voltage value is calculated by the on and off time. $V_{out} = (T_{on}/ T) * V_{max}$.

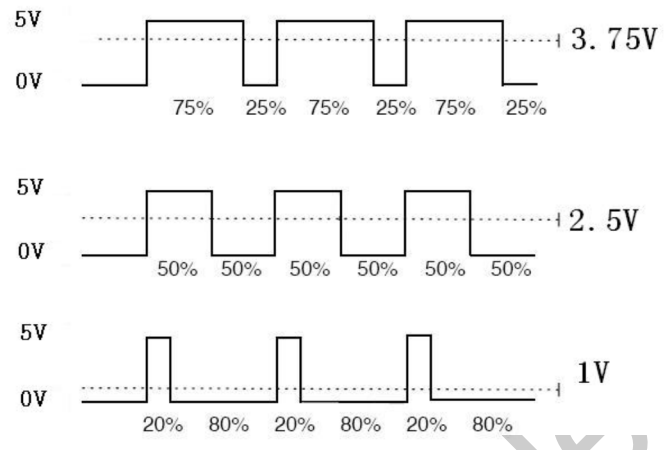

We can see from the top oscillogram that the amplitude of DC voltage output is 5V. However, the actual voltage output is only 3.75V through PWM, for the high level only takes up 75% of the total voltage within a period.

Here is the introduction to three basic parameters of PWM:

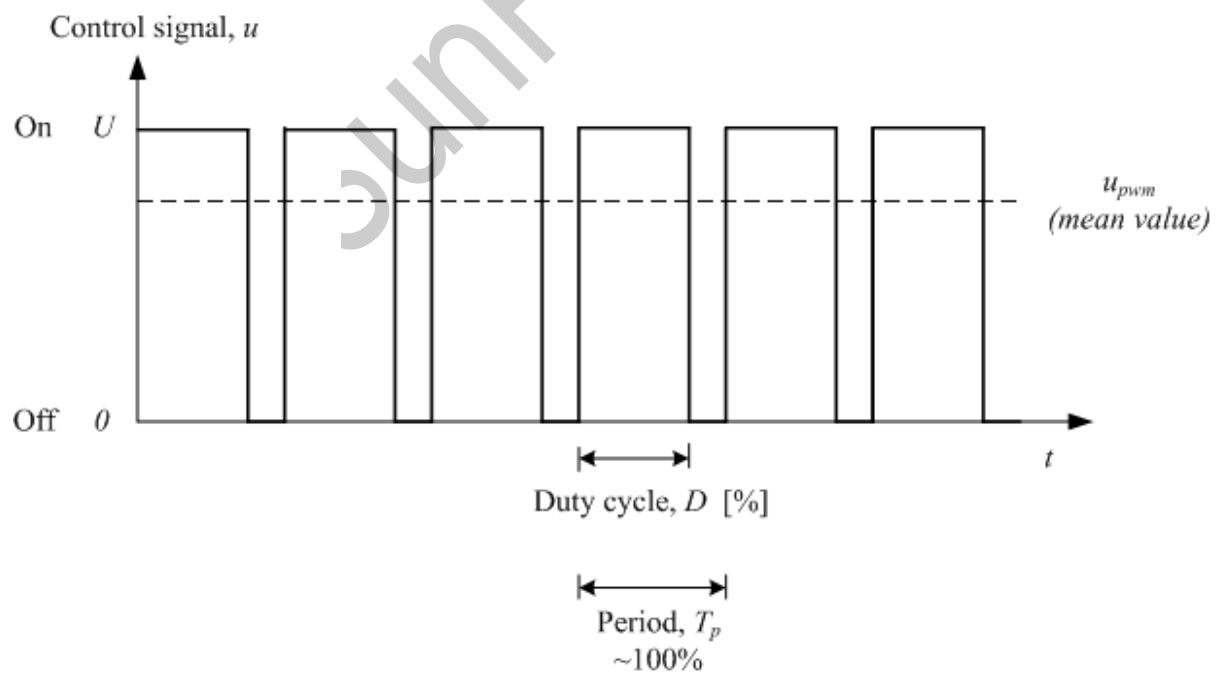

1. The term **duty cycle** describes the proportion of 'on' time to the regular interval or 'period' of time

2. **Period** describes the reciprocal of pulses in one second
3. **U_{pwm}** describes the mean value of output voltage (e.g. 0V-5V)

Here we input any value between 0 and 255 to the three pins of the RGB LED to make it flash different colors.

RGB LEDs can be categorized into common anode type and common cathode type. In this experiment, we use common cathode RGB LED.

Experimental Procedures

Step 1: Build the circuit

RGB LED Module	SunFounder Uno
R -----	D11
G -----	D10
B -----	D9
- -----	GND

Step 2: Program (Please refer to the example code in [LEARN -> Get Tutorial](#) on our [website](#))

Step 3: Compile

Step 4: Upload the sketch to SunFounder Uno

Now, you can see the RGB LED flash red, green and blue first, and then red, orange, yellow, green, blue, indigo and purple.

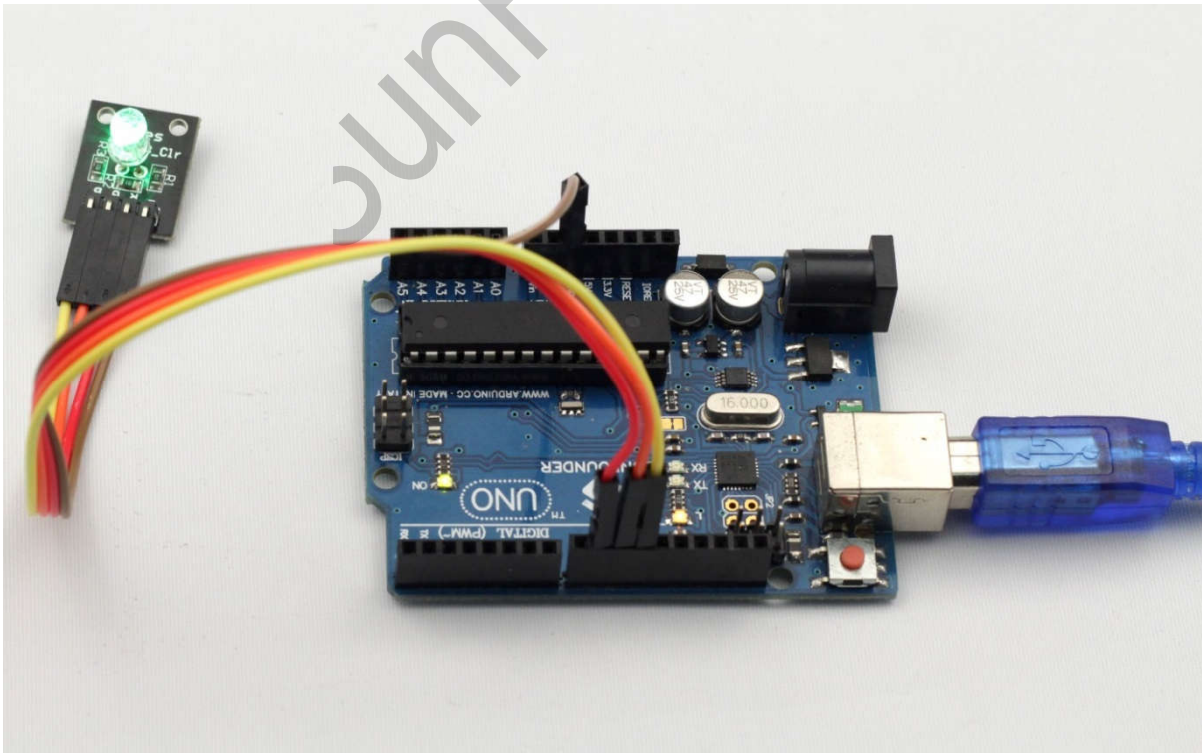

Lesson 3 Dual-color Common-Cathode LED

Introduction

There are two kinds of dual-color Common-Cathode LED in this kit. The only difference is the package size of the LED, as shown below:



Components

- 1 * SunFounder Uno board
- 1 * USB data cable
- 1 * Dual-color Common-Cathode LED module
- Several jumper wires

Experimental Principle

Control the LED brightness by the digital port. The color of the LED changes from yellow to red as well as flashes a mixed color.

Experimental Procedures

Step 1: Build the circuit

Dual-color Common-Cathode LED	SunFounder Uno
Y -----	D10
- -----	GND
R -----	D11

Step 2: Program (Please refer to the example code in [LEARN -> Get Tutorial](#) on our [website](#))

Step 3: Compile

Step 4: Upload the sketch to SunFounder Uno

Now, you can see the dual-color LED flashing yellow, red, and mixed colors.



Lesson 4 Shock Switch

Introduction

A shock switch (as shown below), also vibration switch, spring switch or shock sensor, is an electronic switch which senses vibration amplitude and transfers the signals to circuit device thus switching on the circuit. It composes of conductive vibration spring, switch, trigger pin, packaging agent and so on.

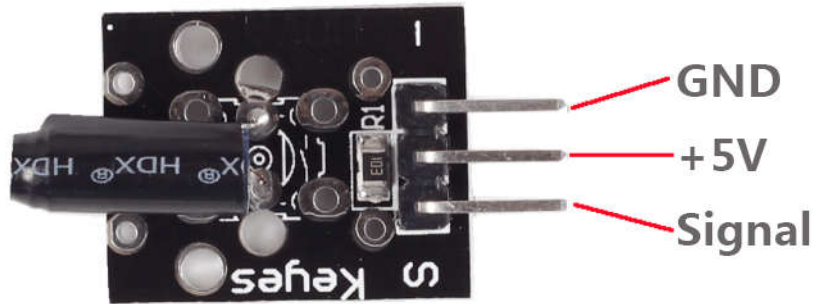

Components

- 1 * SunFounder Uno board
- 1 * USB data cable
- 1 * Shock switch module
- Jumper wires

Experimental Principle

The shock switch works like this: the conductive vibration spring and trigger pin are precisely placed in the switch and fixed by adhesive. Normally, the spring and the trigger pin are separated. Once the sensor detects shock, the spring will vibrate and contact with the trigger pin, thus conducting and generating trigger signals.

With the LED attached to pin 13 already, connect the shock switch to digital pin 8. When the shock switch induces shock signals, the LED will light up.

Experimental Procedures

Step 1: Build the circuit

Shock Switch Module	SunFounder Uno
S -----	D8
- -----	GND
+ -----	5V

Step 2: Program (Please refer to the example code in [LEARN -> Get Tutorial](#) on our [website](#))

Step 3: Compile

Step 4: Upload the sketch to SunFounder Uno

Now, shake the switch module and you will see the LED attached to pin 13 on the SunFounder Uno board light up.



Lesson 5 Knock Sensor

Introduction

A knock sensor (as shown below) is similar to the shock switch except that it's more sensitive. It can feel small amplitude vibration.

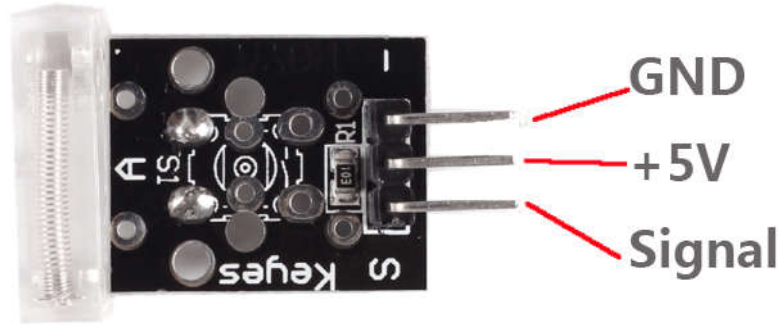

Components

- 1 * SunFounder Uno board
- 1 * USB data cable
- 1 * Knock sensor module
- Several jumper wires

Experimental Principle

The principle is similar to that of the shock switch. Connect the knock switch sensor pin S to D3 to build a simple circuit. When the knock switch sensor inducts knock signals, the LED attached to pin 13 will light up.

Experimental Procedures

Step 1: Build the circuit

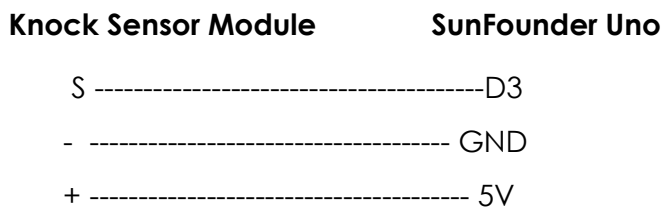

Step 2: Program (Please refer to the example code in [LEARN -> Get Tutorial](#) on our [website](#))

Step 3: Compile

Step 4: Upload the sketch to SunFounder Uno

Now, knock the sensor and the LED attached to pin 13 on the SunFounder Uno board will light up.



Lesson 6 Infrared Transmitter

Introduction

An infrared transmitter module (as shown below) is a device that uses 38K modulation signal generated by MCU to emit infrared rays.

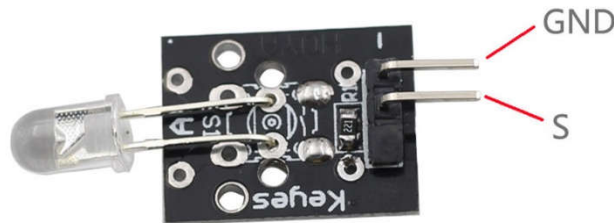

Components

- 1 * SunFounder Uno board
- 1 * USB data cable
- 1 * Infrared transmitter module
- 1 * LCD1602
- 1 * Potentiometer
- Several jumper wires

Experimental Principle

An infrared transmitter is a device applied in remote control. It can emit rays within a certain range through an infrared transmitting tube so as to control signals. Infrared transmitter is widely used in consumer electronics, industry and communication, etc.

In this experiment, connect pin S of the infrared transmitter module to D3 to build a simple circuit. When the coded value for an infrared ray is input by programming and then the infrared transmitter module emits the infrared ray, the LED attached to pin 13 will light up. In addition, the coded value of the infrared ray will be displayed on LCD1602.

Experimental Procedures

Step 1: Build the circuit

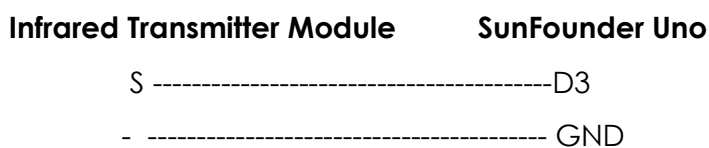

LCD1602 connection: connect pin RS to digital pin 5; R/W to GND; E to digital pin 4; D4-D7 to digital pin 9 to 12; VSS to GND; VDD to 5V; A to 3.3V; K to GND

Potentiometer connection: Connect the middle pin to VO of LCD1602 and any other pin to GND

Step 2: Program (Please refer to the example code in [LEARN -> Get Tutorial](#) on our [website](#))

Step 3: Compile

Step 4: Upload the sketch to SunFounder Uno

Now, you can see the infrared transmitter emit infrared rays through a camera or your phone camera. At the same time, the LED attached to pin 13 on SunFounder Uno board lights up and a coded value is displayed on the LCD.

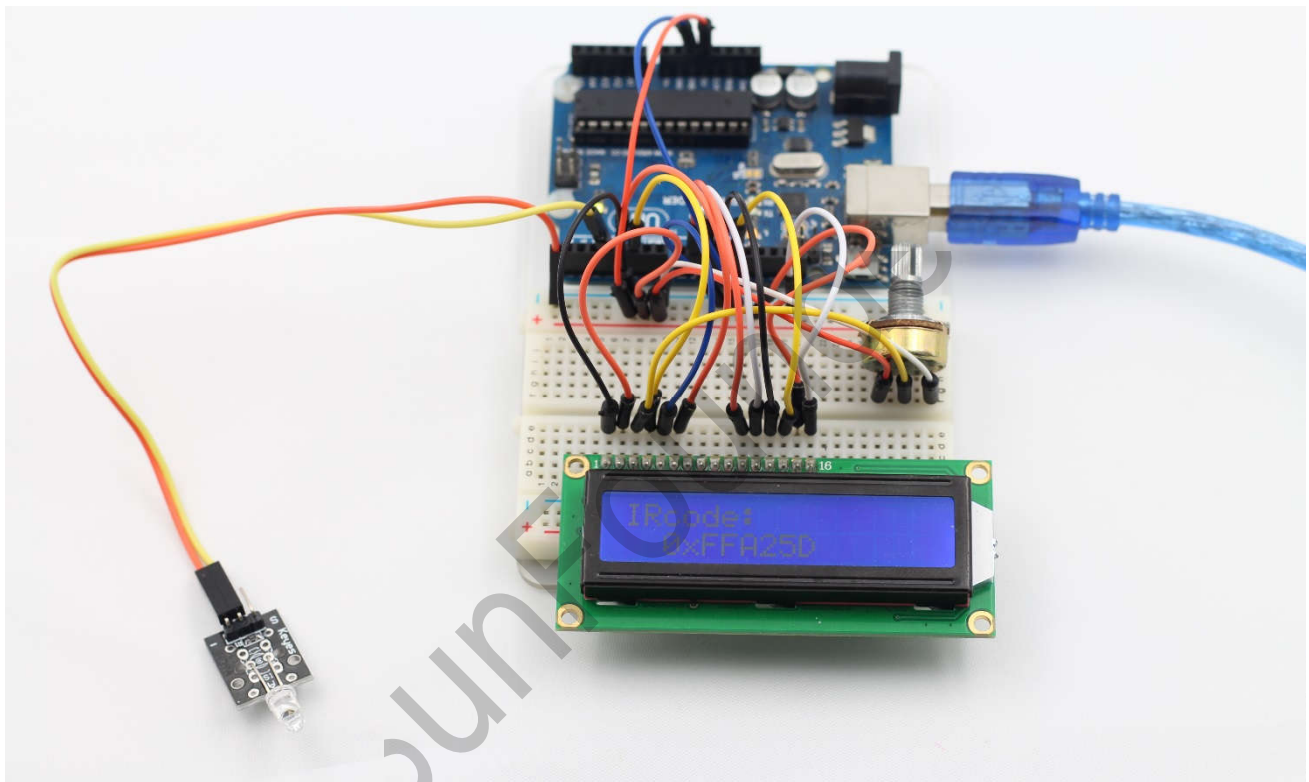

Lesson 7 Laser Transmitter

Introduction

Laser is widely used in medical treatment, military, and other fields due to its good directivity and energy concentration. The Laser Transmitter module (as shown below), as the name suggests, is a one that can emit laser.

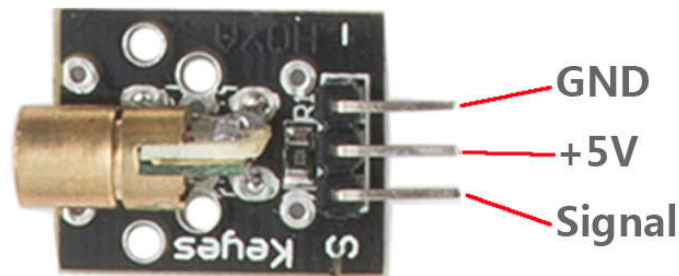

Components

- 1 * SunFounder Uno board
- 1 * USB data cable
- 1 * Laser transmitter module
- Several jumper wires

Experimental Principle

A laser is a device that emits light through a process of optical amplification based on the stimulated emission of electromagnetic radiation. Lasers differ from other sources of light because they emit light coherently.

Spatial coherence allows a laser to be focused to a tight spot, enabling applications like laser cutting and lithography, and a laser beam to stay narrow over long distances (collimation), enabling applications such as laser pointer. Lasers can also have high temporal coherence which allows them to have a very narrow spectrum, i.e., they only emit a single color of light. And its temporal coherence can be used to produce pulses of light—as short as a femtosecond.

Experimental Procedures

Step 1: Build the circuit

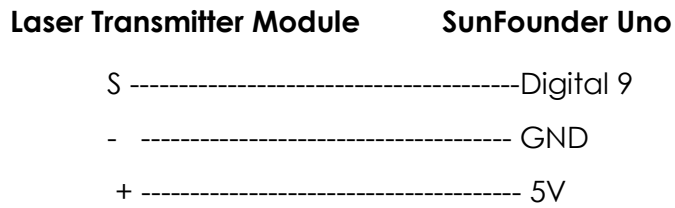

Step 2: Program (Please refer to the example code in [LEARN -> Get Tutorial](#) on our [website](#))

Step 3: Compile

Step 4: Upload the sketch to SunFounder Uno

Now, you can see the laser transmitter module send out Morse signals.



Note: DO NOT look directly at the laser head. It can cause great harm to your eyes.

Lesson 8 Reed Switch

Introduction

A reed switch (as shown below) is a sensor used to detect the magnetic field. Hall sensors are generally used to measure the speed of smart car and count products on assembly lines. Reed switches are often used to detect the existence of magnetic field.

There are two reed switches in this kit: reed switch and mini reed. They work in the same principle.



Components

- 1 * SunFounder Uno board
- 1 * USB data cable
- 1 * Reed switch module
- Several jumper wires

Experimental Principle

A reed switch is a type of line switch component that realizes control by magnetic signals. It induces by a magnet. The "switch" here means dry reed pipe, which is a kind of contact passive electronic switch component with the advantage of simple structure, small size, and convenient control. The shell of a reed switch is commonly a sealed glass pipe in which two iron elastic reed electroplates are equipped and inert gases are filled.

Normally, the two reeds made of special materials in the glass tube are separated. However, when a magnetic substance approaches the glass tube, the two reeds in the glass tube are magnetized to attract each other and get touched due to the magnetic force. As a result, the two reeds close the circuit connected with the nodes.

After the external magnetic force disappears, the two reeds will be separated with each other again because their like poles are placed near which intend to repel them apart, thus

breaking the circuit. Therefore, as line switch components function by magnetic signals, they can be used to count stuff, restrict positions and so on. At the same time, it is widely used in a variety of communication devices.

In this experiment, since an LED has been attached to pin 13, just connect pin D0 of the reed switch to D8 of the SunFounder Uno board. When the reed switch inducts magnetic field signals, the LED will be on. Otherwise, it will be off.

Experimental Procedures

Step 1: Build the circuit

Reed Switch Module	SunFounder Uno
AO -----	A0
DO -----	D8
- -----	GND
+ -----	5V

Step 2: Program (Please refer to the example code in [LEARN -> Get Tutorial](#) on our [website](#))

Step 3: Compile

Step 4: Upload the sketch to SunFounder Uno

Now, put a magnet close to the reed switch, and you will see the LED attached to pin 13 on the SunFounder Uno board light up.

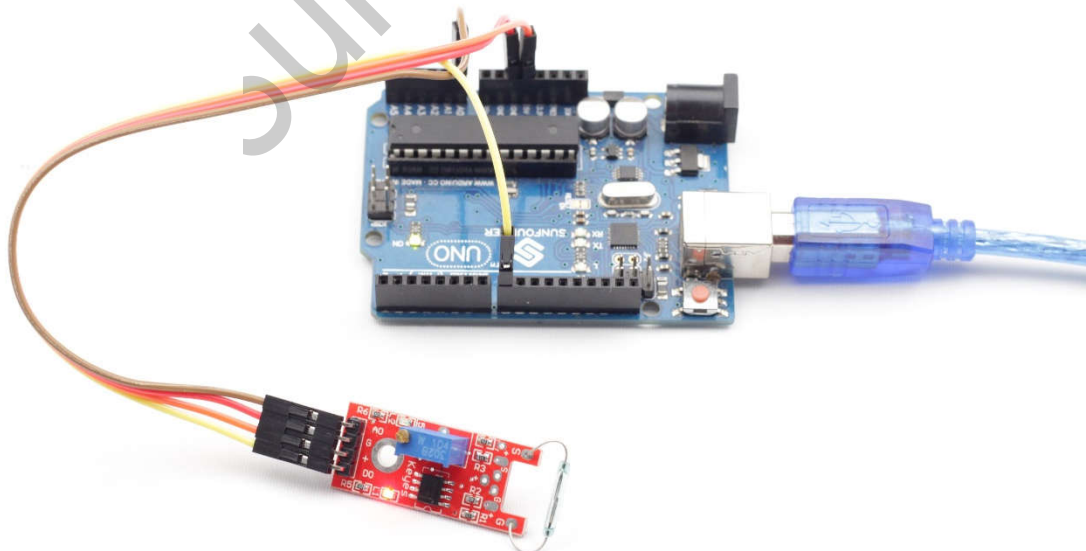

Mini Reed

The experimental procedures are the same as those of Reed Switch. Connect pin S to D2 of the SunFounder board, and you will see the LED attached to pin 13 light up when a magnet approaches the mini reed.

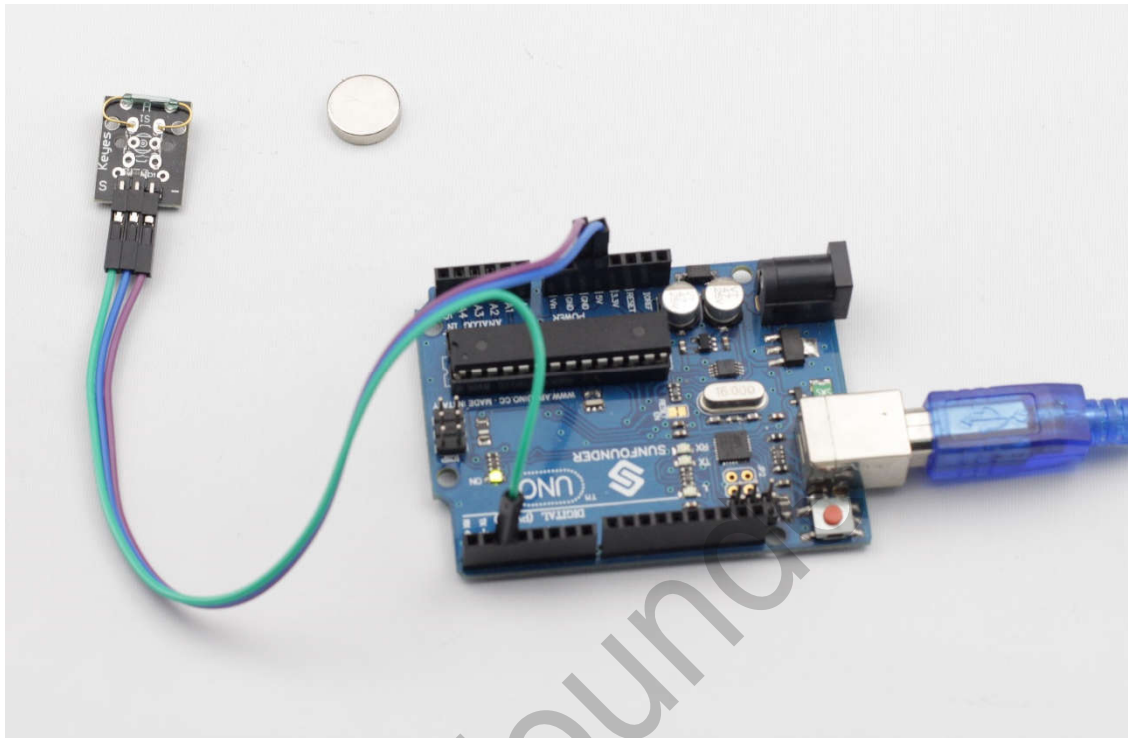

Lesson 9 Infrared-Receiver

Introduction

An infrared-receiver is a component that receives infrared signals and can independently receive infrared ray and output signals compatible with TTL level. It's similar with a normal plastic-packaged transistor in size and it is suitable for all kinds of infrared remote control and infrared transmission.

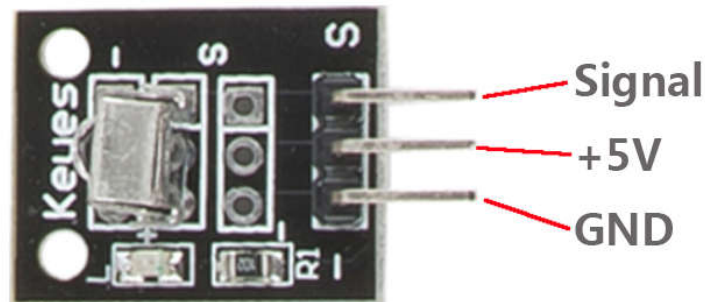

Components

- 1 * SunFounder Uno board
- 1 * USB data cable
- 1 * Infrared-Receiver module
- 1 * Remote controller
- Several jumper wires

Experimental Principle

Control a certain key (for example, Power key) via a remote controller by programming. When you press the key, infrared rays will be emitted from the remote controller and received by the infrared receiver, and the LED on the SunFounder Uno board will light up.

Experimental Procedures

Step 1: Build the circuit

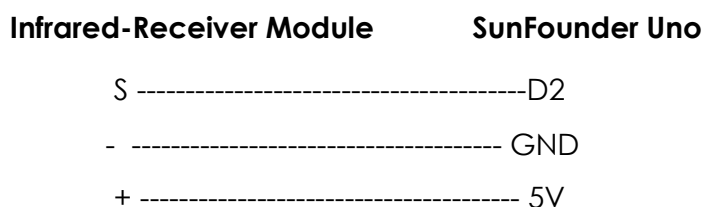

Step 2: Program (Please refer to the example code in [LEARN -> Get Tutorial](#) on our [website](#))

Step 3: Compile

Step 4: Upload the sketch to SunFounder Uno

Now, press Power on the remote control and the LED attached to pin 13 on the SunFounder Uno board will light up. If you press other keys, the LED will go out.



Lesson 10 Analog Temperature Sensor

Introduction

A thermistor is the core component of an analog temperature sensor (as shown below).

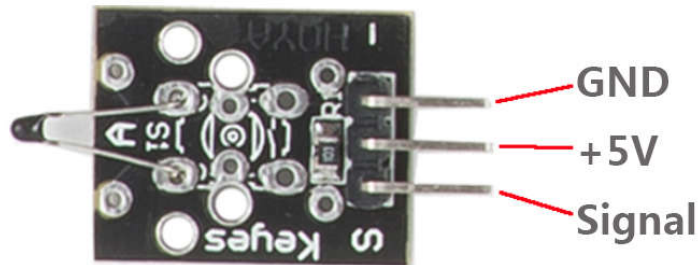

Components

- 1 * SunFounder Uno board
- 1 * USB data cable
- 1 * Analog Temperature Sensor module (thermistor)
- 1 * LCD1602
- 1 * Potentiometer
- Several jumper wires

Experimental Principle

This module is based on thermistor principle, whose resistance varies significantly with ambient temperature changes. It can detect surrounding temperature changes in real time and send the temperature data to analog I/O port of the SunFounder Uno board. You only need to convert the output to Celsius temperature by simple programming and display it on an LCD.

Experimental Procedures

Step 1: Build the circuit

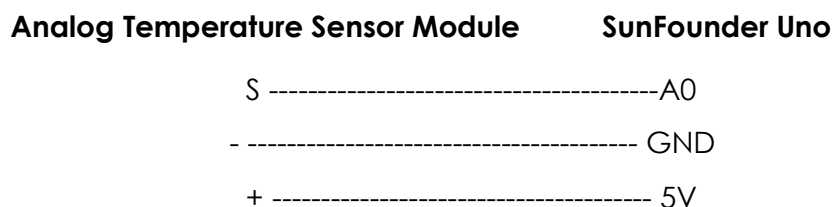

LCD1602 connection: connect pin RS to digital pin 4; R/W to GND; E to digital pin 5; D4~D7 to digital pin 9 to 12; VSS to GND; VDD to 5V; A to 3.3V; K to GND

Potentiometer connection: Connect the middle pin to VO of LCD1602 and any other pin to GND

Step 2: Program (Please refer to the example code in [LEARN -> Get Tutorial](#) on our [website](#))

Step 3: Compile

Step 4: Upload the sketch to SunFounder Uno

Now, touch the thermistor and you can see the current temperature displayed on the LCD in both Celcius and Fahrenheit degrees.

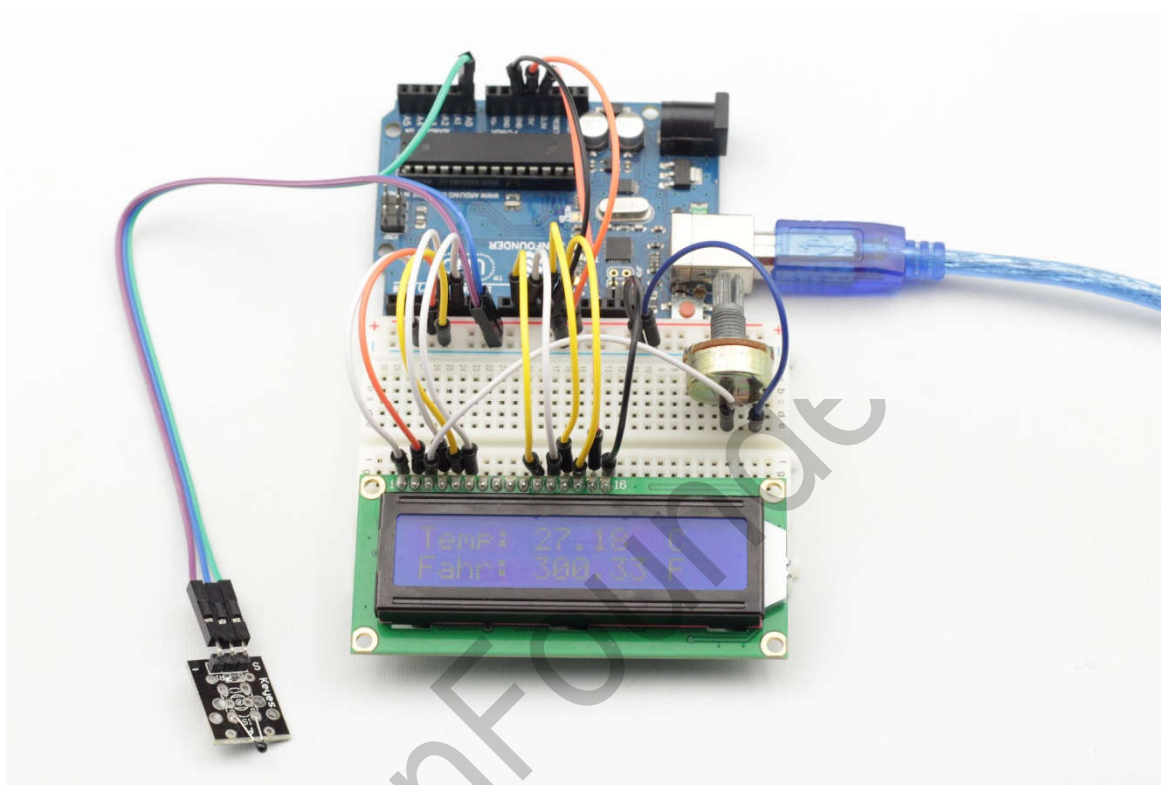

Lesson 11 Digital Temperature Sensor

Introduction

Compared with an analog temperature sensor, a digital temperature sensor (as shown below) only adds a digital output. You can adjust the threshold by the potentiometer onside. When the output is higher than the threshold, the sensor will output high level; when it is lower than the threshold, the sensor will output low level.

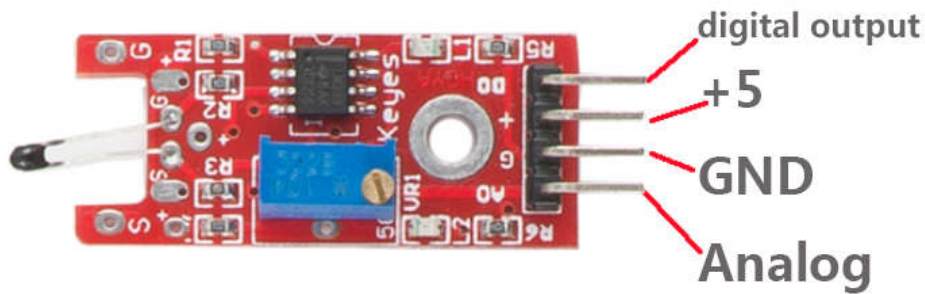

Components

- 1 * SunFounder Uno board
- 1 * USB data cable
- 1 * Digital Temperature Sensor module
- Several jumper wires

Experimental Principle

In this experiment, we will use a Digital-temperature Sensor module and an LED attached to pin 13 of SunFounder to build a simple circuit to make a temperature light.

With the LED attached to pin 13, connect the pin DO to D7 of SunFounder Uno. When the Digital Temperature Sensor detects that the ambient temperature is higher than a certain value (threshold), the LED will be on. Otherwise, it will be off. You can adjust the threshold by adjusting the potentiometer.

Experimental Procedures

Step 1: Build the circuit

Digital Temperature Sensor Module	SunFounder Uno
AO -----	A0
DO -----	D7
- -----	GND
+ -----	5V

Step 2: Program (Please refer to the example code in [LEARN -> Get Tutorial](#) on our [website](#))

Step 3: Compile

Step 4: Upload the sketch to SunFounder Uno

Now, touch the thermistor and you will see the LED attached to pin 13 on SunFounder Uno board light up after a while.

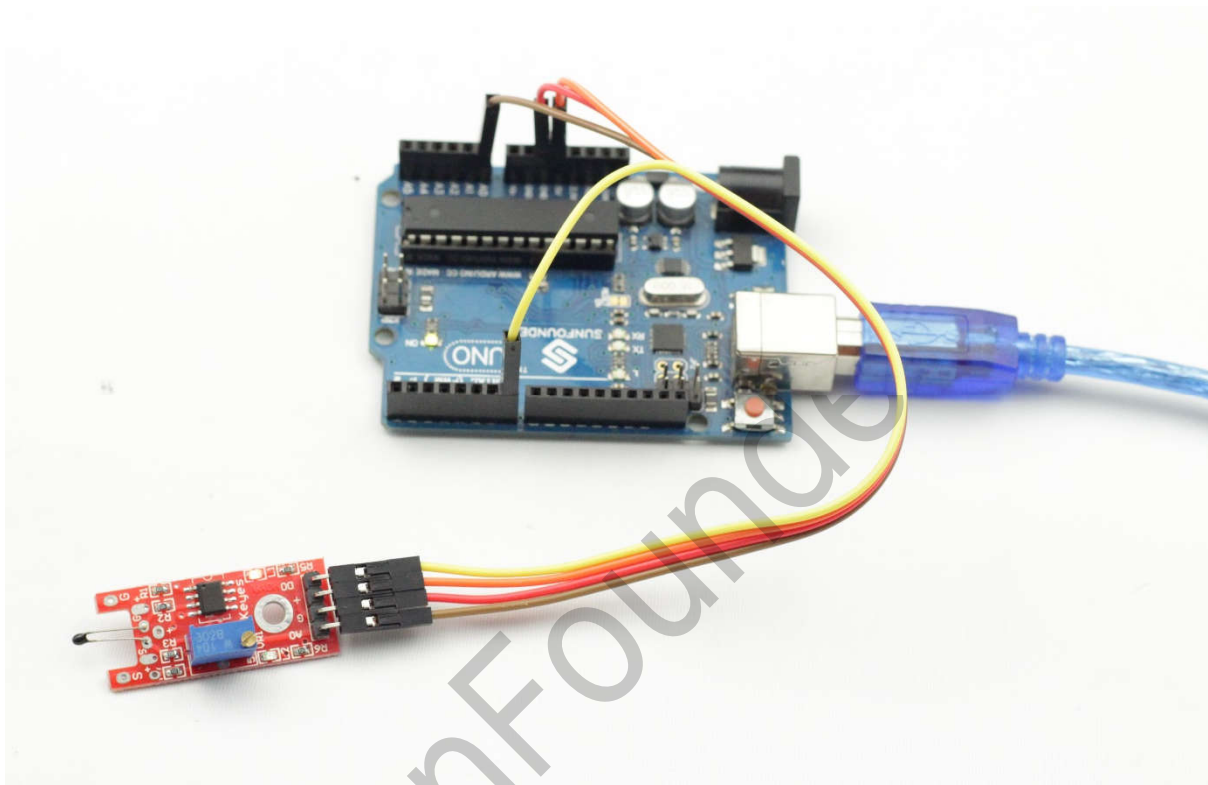

Lesson 12 Buzzer

Introduction

Buzzers can be categorized as active buzzers and passive ones (See the following picture).



Components

- 1 * SunFounder Uno board
- 1 * USB data cable
- 1 * Buzzer module
- Several jumper wires

Experimental Principle

Place the pins of two buzzers face up and you can see the one with a green circuit board is a passive buzzer, while the other with a black tape, instead of a board, is an active buzzer, as shown below.



An active buzzer has a built-in oscillating source, so it will make sounds when electrified. But a passive buzzer does not have such source, so it will not beep if DC signals are used; instead, you need to use square waves whose frequency is between 2K and 5K to drive it. The active buzzer is often more expensive than the passive one because of multiple built-in oscillating circuits.

Experimental Procedures

Passive Buzzer

Step 1: Build the circuit

Passive Buzzer Module	SunFounder Uno
S -----	D11
- -----	GND
+ -----	5V

Step 2: Program (Please refer to the example code in [LEARN -> Get Tutorial](#) on our [website](#))

Step 3: Compile

Step 4: Upload the sketch to SunFounder Uno

Now, you can hear the passive buzzer beep for warning.



Active Buzzer

Note: The active buzzer has built-in oscillating source, so it will beep as long as it is electrified, but it can only beep with a fixed frequency.

Step 1: Build the circuit

Active Buzzer Module	SunFounder Uno
S -----	D1
- -----	GND
+ -----	5V

Step 2: Program (Please refer to the example code in [LEARN -> Get Tutorial](#) on our [website](#))

Step 3: Compile

Step 4: Upload the sketch to SunFounder Uno

Now, you can hear the active buzzer beep.

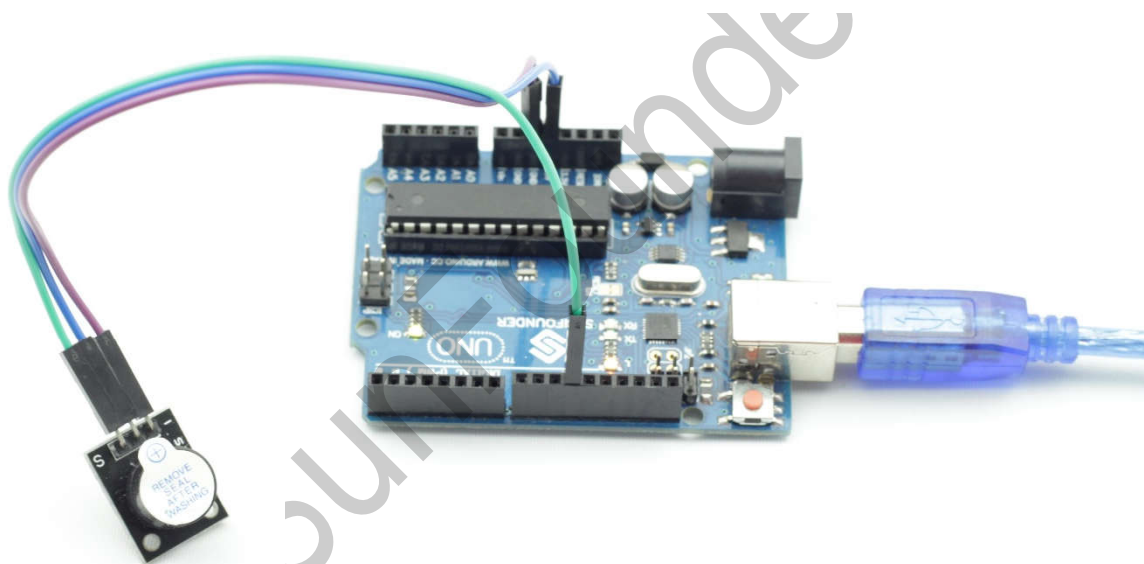

Lesson 13 Button Switch

Introduction

Most SunFounder boards already have an LED attached to pin 13 itself. So we will use a button module and this LED to build a simple circuit and make an LED brighten.

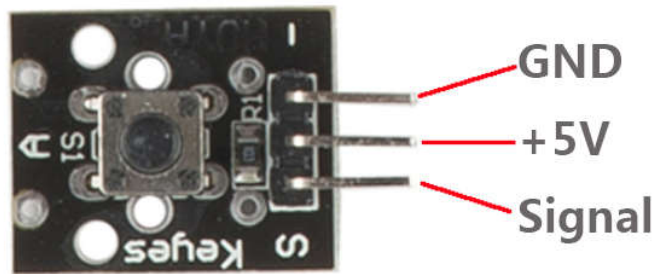

Components

- 1 * SunFounder Uno board
- 1 * USB data cable
- 1 * Button module
- Several jumper wires

Experimental Principle

With the LED attached to pin 13, connect the button module to digital pin 8. When the button module inducts button-pressing signals, the LED will be on. Otherwise, it will be off.

Experimental Procedures

Step 1: Build the circuit

Button Module	SunFounder Uno
S	Digital 8
-	GND
+	5V

Step 2: Program (Please refer to the example code in [LEARN -> Get Tutorial](#) on our [website](#))

Step 3: Compile

Step 4: Upload the sketch to SunFounder Uno

Now, press the button and the LED attached to pin 13 on the SunFounder Uno board will light up.

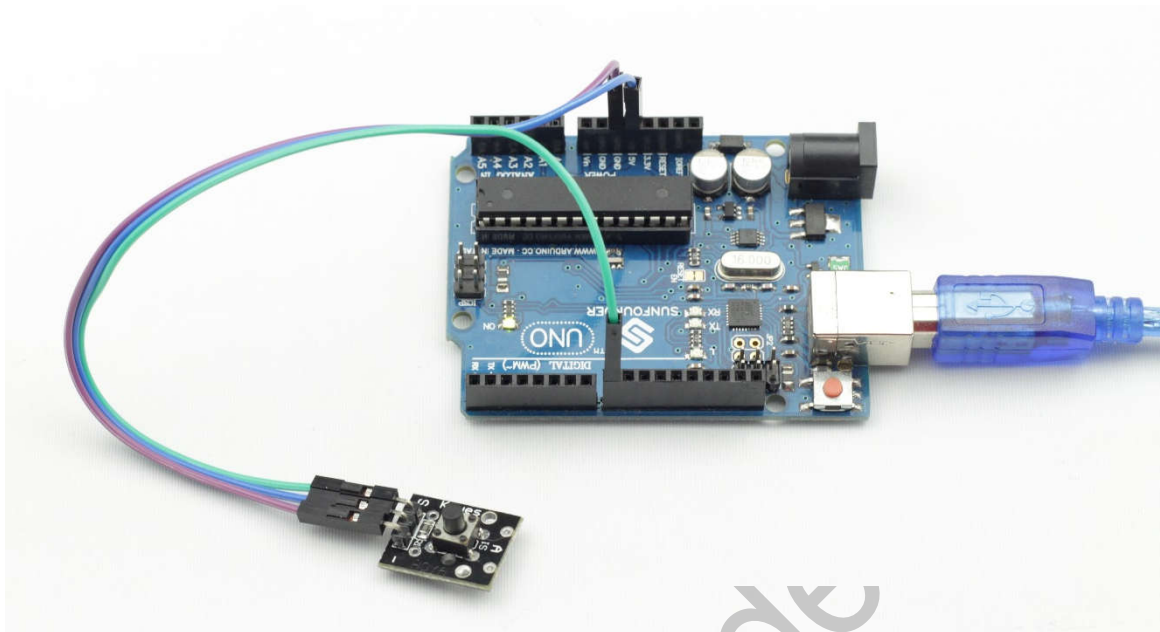

Lesson 14 Photo-interrupter

Introduction

A photo-interrupter is a sensor that arranges light-emitting component and light-receiving component face-to-face and packages them together. It applies the principle that light is interrupted when an object passes through the sensor. Therefore, photo-interrupters are widely used in speed measurement.

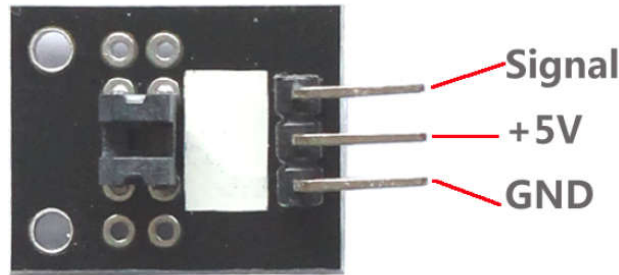

Components

- 1 * SunFounder Uno board
- 1 * USB data cable
- 1 * Photo-interrupter module
- Several jumper wires

Experimental Principle

Basically a photo-interrupter consists of two parts: transmitter and receiver. The transmitter (e.g., an LED or a laser) emits light and then the light goes to the receiver. If that light beam between the transmitter and receiver is interrupted by an obstacle, the receiver will detect no incoming light even for a moment and the output level will change. In this experiment, we will turn an LED on or off by using this change.

Experimental Procedures

Step 1: Build the circuit

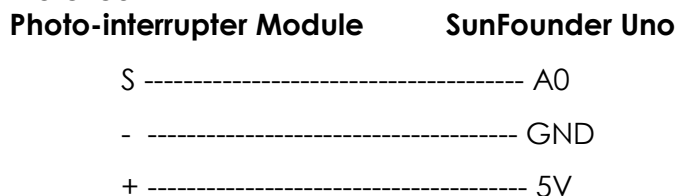

Step 2: Program (Please refer to the example code in [LEARN -> Get Tutorial](#) on our [website](#))

Step 3: Compile

Step 4: Upload the sketch to SunFounder Uno

Now, stick a piece of paper in the gap of the sensor, and the LED attached to pin 13 on the SunFounder Uno will go out; remove the paper, and then the LED will light up again.

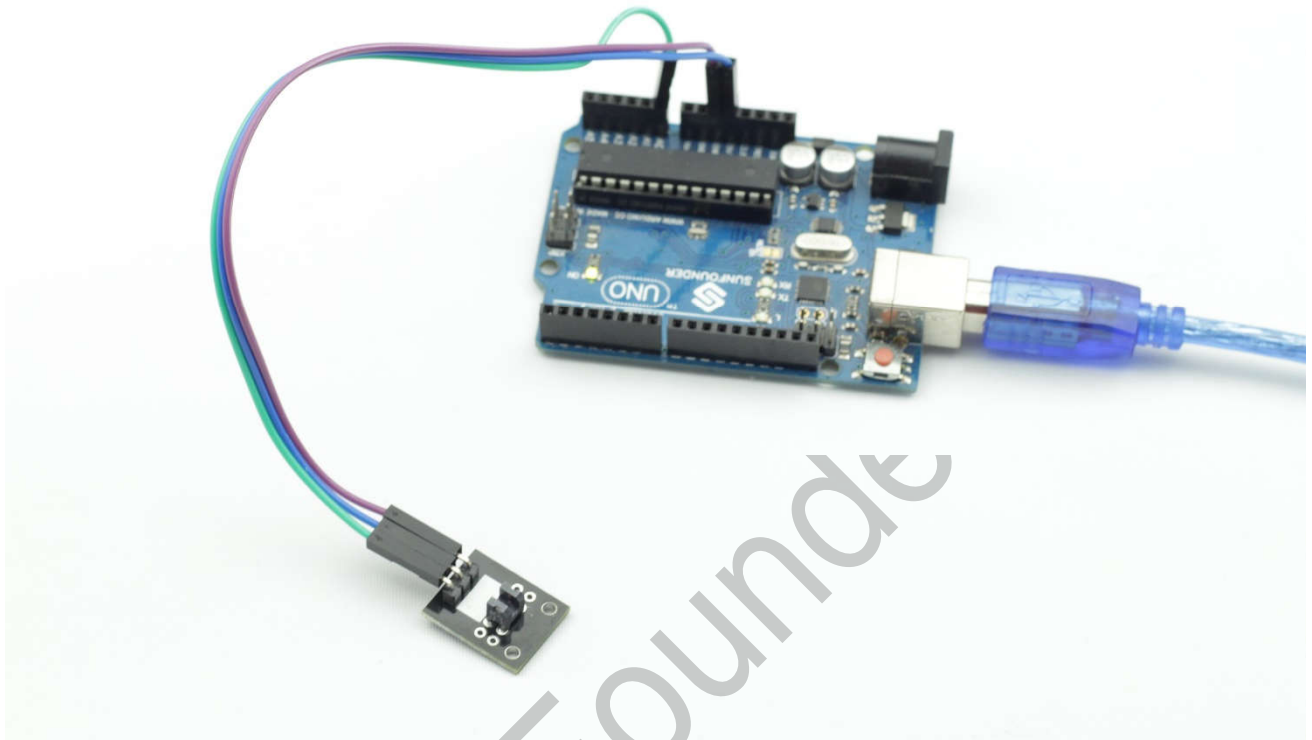

Lesson 15 Tilt-Switch

Introduction

The tilt switch sensor module is a ball tilt switch with a metal ball inside. It is used to detect inclinations of a small angle.

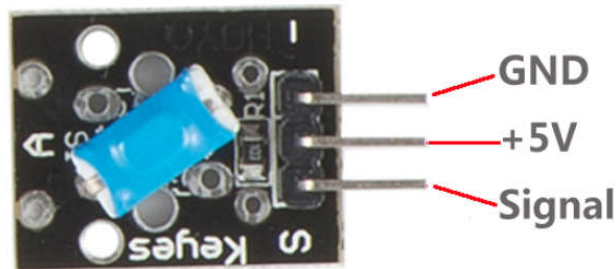

Components

- 1 * SunFounder Uno board
- 1 * USB data cable
- 1 * Tilt-switch module
- Several jumper wires

Experimental Principle

Apply the principle that the ball in the switch moves with different angles of inclination to make triggering circuits. The tilt switch module uses a ball tilt switch with bidirectional conduction. When it tilts towards either side, as long as the tilt degree and force meet the condition, the switch will be energized; thus, it will output low level signals.

In this experiment, we use a tilt switch module and an LED that has been attached to pin 13 of the SunFounder board to build a simple circuit.

With the LED attached to pin 13, connect pin S to D2 of SunFounder Uno board. When the Tilt-switch inducts tilt signals, the LED will be on. Otherwise, it will be off.

Experimental Procedures

Step 1: Build the circuit

Tilt-switch Module	SunFounder Uno
S	D2
-	GND
+	5V

Step 2: Program (Please refer to the example code in [LEARN -> Get Tutorial](#) on our [website](#))

Step 3: Compile

Step 4: Upload the sketch to SunFounder Uno

Now, tilt the switch and the LED attached to pin 13 on the SunFounder Uno board will light up.

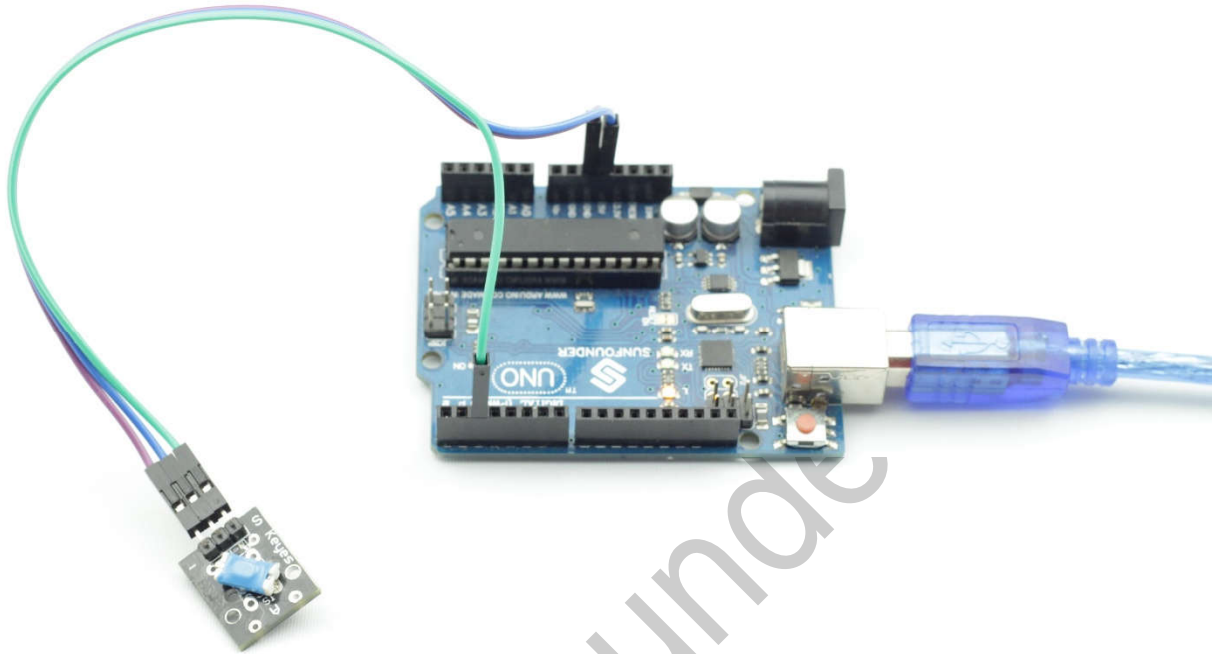

Lesson 16 Mercury Switch

Introduction

Similar to a tilt switch, a mercury switch is used to detect slight inclinations of a large angle. A mercury switch (also known as a mercury tilt switch) is a switch which opens and closes an electrical circuit through a small amount of liquid mercury.

Mercury switches have one or more sets of electrical contacts in a sealed glass envelope which contains a bead of mercury. The envelope may also contain air, an inert gas, or a vacuum. Gravity is constantly pulling the drop of mercury to the lowest point in the envelope. When the switch is tilted in the appropriate direction, the mercury touches a set of contacts, thus completing the electrical circuit through those contacts. Tilting the switch the opposite direction causes the mercury to move away from that set of contacts, thus breaking that circuit.

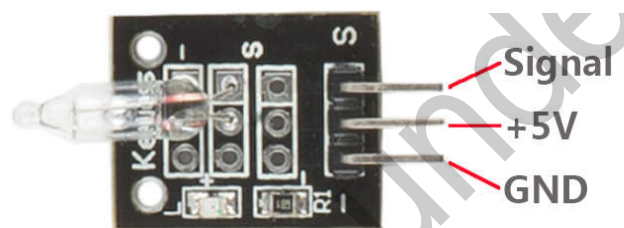

Components

- 1 * SunFounder Uno board
- 1 * USB data cable
- 1 * Mercury switch module
- Several jumper wires

Experimental Principle

Since the LED has been attached to pin 13, just connect pin S to D2 of the SunFounder Uno board. When the mercury switch inducts tilt signals, the LED will be on. Otherwise it will be off.

Note: Mercury is harmful to human body and environment. Thus, please BE CAREFUL when using a mercury switch in case of glass breaking. It should also be properly handled if it's no longer used.

Experimental Procedures

Step 1: Build the circuit

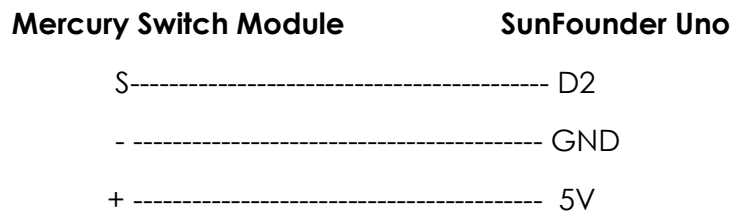

Step 2: Program (Please refer to the example code in [LEARN -> Get Tutorial](#) on our [website](#))

Step 3: Compile

Step 4: Upload the sketch to SunFounder Uno

Now, tilt the switch and the LED attached to pin 13 on the SunFounder Uno board will light up.



Lesson 17 Magic Cup

Introduction

There are two same Magic Cup modules in this kit, and each adds a separate LED based on the mercury switch. You may learn the application of one module and then try to apply two modules together to make one dim when at the same time the other brightens.

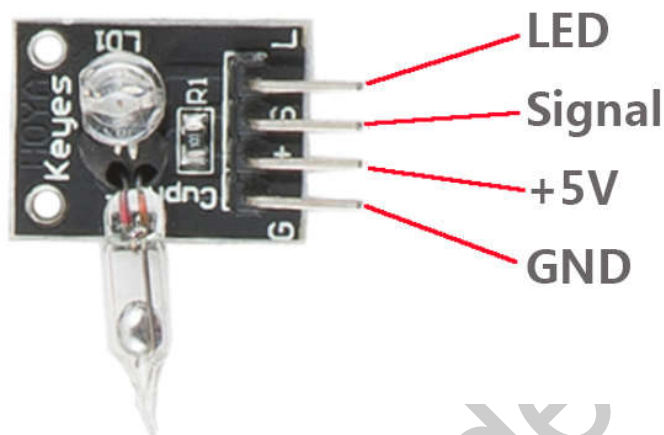

Components

- 1 * SunFounder Uno board
- 1 * USB data cable
- 2 * Magic cup module
- Several jumper wires

Experimental Principle

Connect pin S and pin L of one module to digital pin 7 and pin 5 of the SunFounder Uno board; pin S and pin L of the other module to D4 and pin 6 of the Uno.

When you tilt one mercury switch, the LED attached will become dimmer gradually, while the other LED will slowly brighten. The effect is just like the telepathy.

Experimental Procedures

Step 1: Connect pin S and pin L of one module to D7 and pin 5 of the SunFounder Uno; pin S and pin L of the other module to D4 and pin 6 of Uno.

Step 2: Program (Please refer to the example code in [LEARN -> Get Tutorial](#) on our [website](#))

Step 3: Compile

Step 4: Upload the sketch to SunFounder Uno

Now, tilt the breadboard and you will see the LED on one module gets dimmer while that on the other LED becomes brighter.

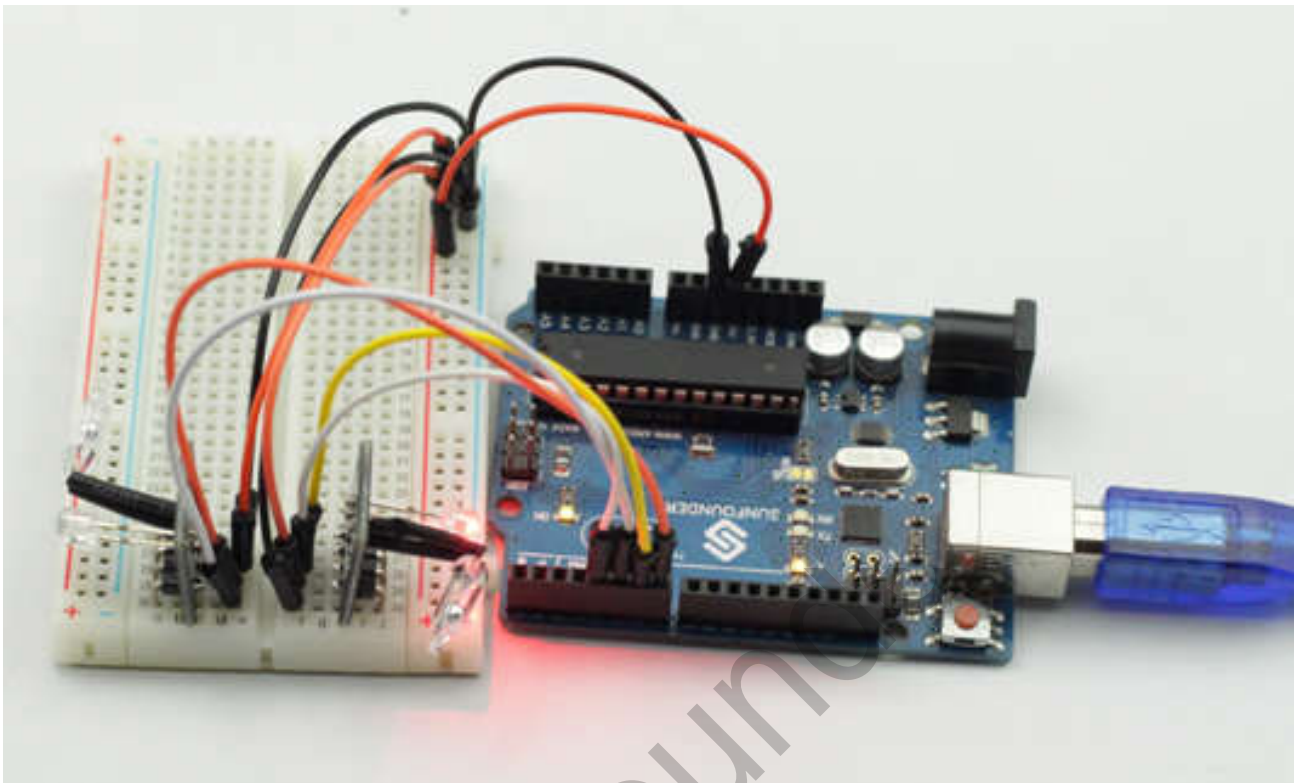

Lesson 18 DS18B20 Temperature Sensor

Introduction

The Temperature Sensor DS18B20 is a commonly used digital temperature sensor featured with small size, low-cost hardware, strong anti-interference capability and high precision. The digital temperature sensor is easy to wire and can be applied a various occasions after packaging. Different from conventional AD collection temperature sensors, it uses a 1-wire bus and can directly outputs temperature data.

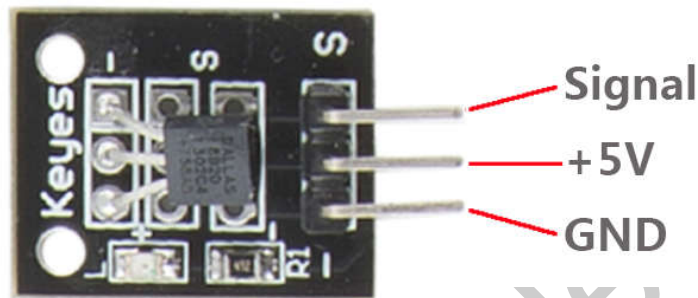

Components

- 1 * SunFounder Uno board
- 1 * USB data cable
- 1 * DS18B20 Temperature Sensor module
- 1 * LCD1602
- 1 * Potentiometer
- Several jumper wires

Experimental Principle

With a unique single-wire interface, DS18B20 requires only one pin for a two-way communication with a microprocessor. It supports multi-point networking to measure multi-point temperatures. Eight DS18B20s can be connected at most, because too many of them will consume too much of the power supply and cause low voltage thus instability of signal transmission.

Experimental Procedures

Step 1: Build the circuit

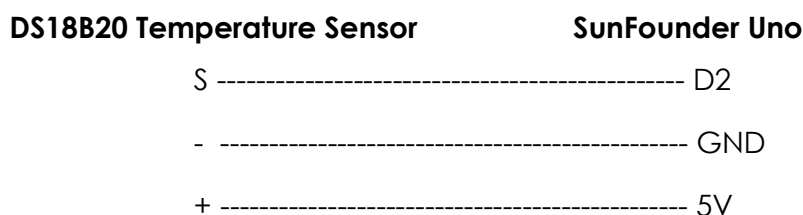

LCD1602 connection: connect pin RS to digital pin 4; R/W to GND; E to digital pin 5; D4~D7 to digital pin 9 to 12; VSS to GND; VDD to 5V; A to 3.3V; K to GND

Potentiometer connection: Connect the middle pin to VO of LCD1602 and any other pin to GND

Step 2: Program (Please refer to the example code in [LEARN -> Get Tutorial](#) on our [website](#))

Step 3: Compile

Step 4: Upload the sketch to SunFounder Uno

Now, you can see the value of the current temperature displayed on the LCD.

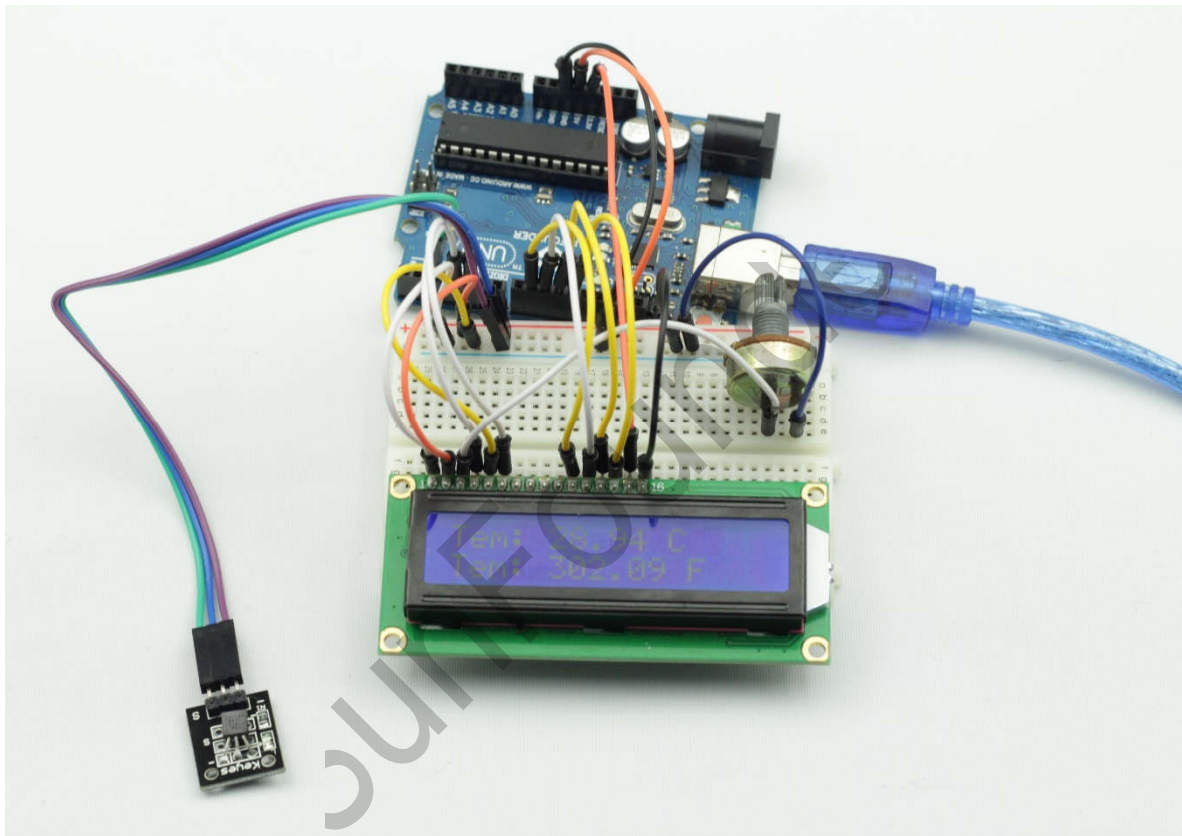

Lesson 19 Rotary Encoder

Introduction

A rotary encoder is an electro-mechanical device that converts the angular position or motion of a shaft or axle to an analog or digital code. Rotary encoders are usually placed at the side which is perpendicular to the shaft. Rotary encoders act as sensors for detecting angle, speed, length, position and acceleration in automation field.

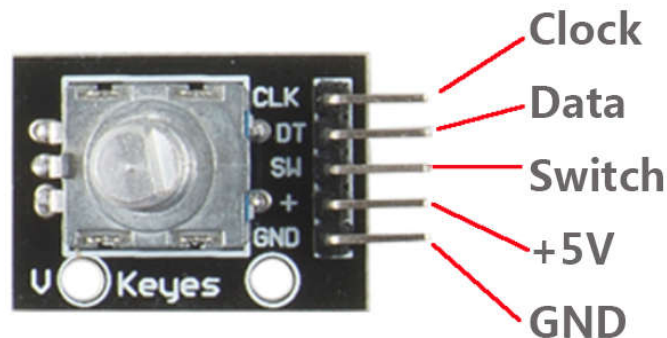

Components

- 1 * SunFounder Uno board
- 1 * USB data cable
- 1 * Rotary Encoder module
- Jumper wires

Experimental Principle

There are mainly two types of rotary encoder: absolute and incremental (relative) ones. The output of absolute encoders indicates the current position of the shaft, making them angle transducers. The output of incremental encoders provides information about the motion of the shaft, which is typically further processed elsewhere into information such as speed, distance, and position.

In this experiment, we will use the latter. An incremental encoder is a rotary sensor to turn rotational displacement into a series of digital pulse signals which are then used to control the angular displacement. It generates two-phase square waves whose phase difference is 90° . Usually the two-phase square waves are called channel A and channel B. See the following figure for details.

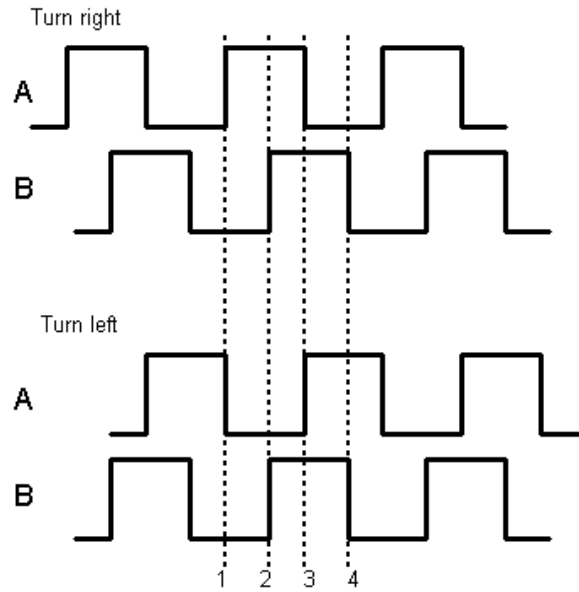

It is difficult to distinguish between the left turn and right turn when programming. However, when using an oscilloscope to observe the left turn and right turn of a switch, you will find a phase difference between the signals of the two output pins as shown below.

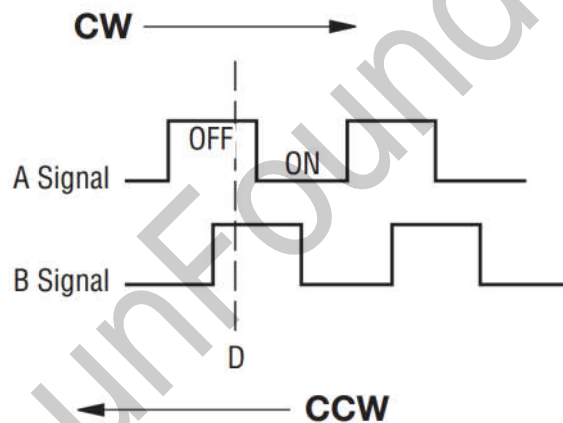

It shows that if output 1 and output 2 is high, then the switch rotates clockwise; if output 1 is high and output 2 is low, then the switch rotates counterclockwise. As a result, during SCM programming, if output 1 is high, then you can tell whether the rotary encoder turns left or right as long as you know the state of output 2.

Experimental Procedures

Step 1: Build the circuit

Rotary Encoder Module	SunFounder Uno
CLK -----	D2
DT -----	D3
SW -----	D4
+ -----	5V
- -----	GND

Step 2: Program (Please refer to the example code in [LEARN -> Get Tutorial](#) on our [website](#))

Step 3: Compile

Step 4: Upload the sketch to SunFounder Uno

Now, you can see the angular displacement of the rotary encoder printed on Serial Monitor. When you spin the rotary encoder clockwise, the angular displacement increases; when you spin it counterclockwise, the value decreases. Press the switch on the rotary encoder and the value will return to zero.

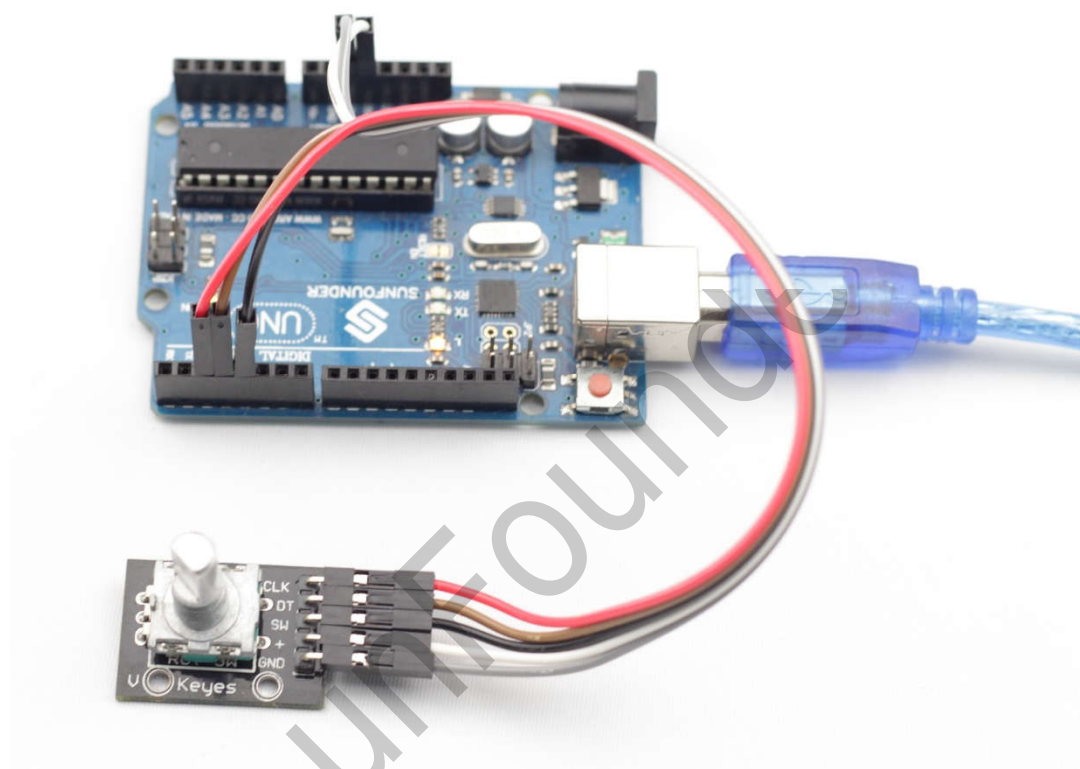

Lesson 20 7-Color Auto-flash LED

Introduction

It can automatically flash built-in colors after power on.

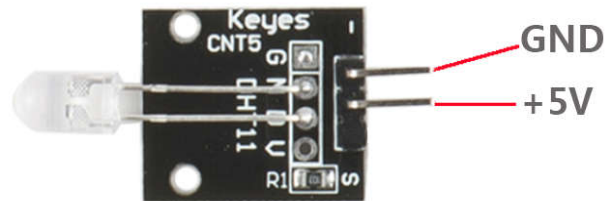

Components

- 1 * SunFounder Uno board
- 1 * USB data cable
- 1 * 7-color auto-flash LED module
- Several jumper wires

Experimental Principle

When being power on, the 7-color auto-flash LED will flash built-in colors.

Experimental Procedures

Just connect pin S to 5V of the SunFounder Uno board and pin - to GND.

Now, you can see the 7-color auto-flash LED flashing seven colors.



Lesson 21 Photoresistor Sensor

Introduction

The sensor is in fact a photoresistor which changes its resistance with varying light intensity. It can be used to make a photoswitch.

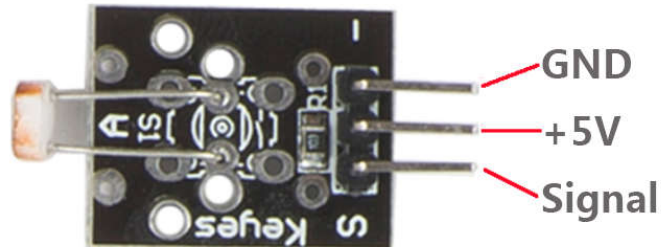

Components

- 1 * SunFounder Uno board
- 1 * USB data cable
- 1 * Photoresistor sensor module
- Jumper wires

Experimental Principle

A photoresistor or light-dependent resistor (LDR) or photocell is a light-controlled variable resistor. The resistance of a photoresistor decreases with increasing incident light intensity; in other words, it exhibits photoconductivity. A photoresistor can be applied in light-sensitive detector circuits, and light- and dark-activated switching circuits.

In this experiment, hook up pin S to an analog port of the SunFounder board. When the light intensity changes, the resistance of photoresistor will change accordingly. Thus it will also change the output voltage of pin S. You can read the output voltage and display it on an LCD to observe this change.

Experimental Procedures

Step 1: Build the circuit

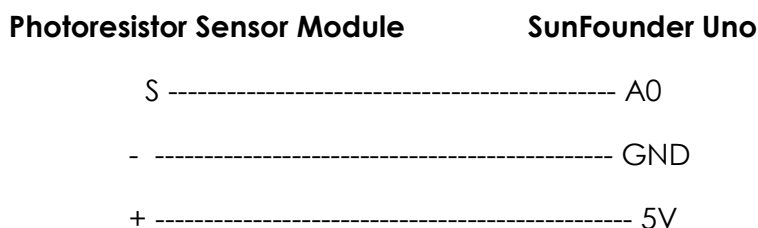

Step 2: Program (Please refer to the example code in [LEARN -> Get Tutorial](#) on our [website](#))

Step 3: Compile

Step 4: Upload the sketch to SunFounder Uno

Now, cover the photoresistor with a cloth or your palm to change the light intensity, and you will find the value displayed on the LCD changes accordingly.

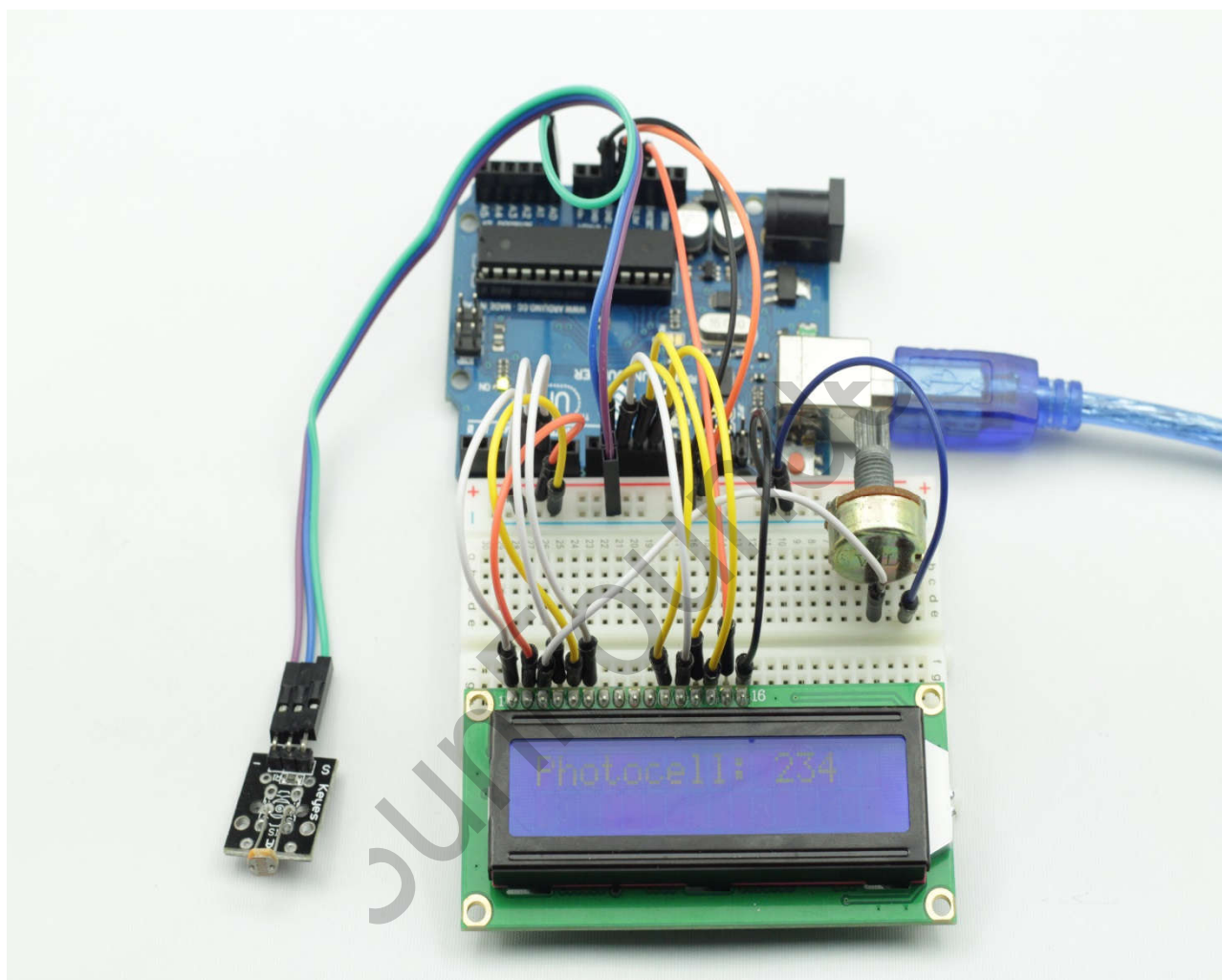

Lesson 22 Humiture Sensor

Introduction

The digital temperature and humidity sensor DHT11 is a composite sensor that contains a calibrated digital signal output of temperature and humidity. The technology of a dedicated digital modules collection and the temperature and humidity sensing technology are applied to ensure that the product has high reliability and excellent long-term stability.

The sensor includes a resistive sense of wet component and an NTC temperature measurement device, and is connected with a high-performance 8-bit microcontroller.

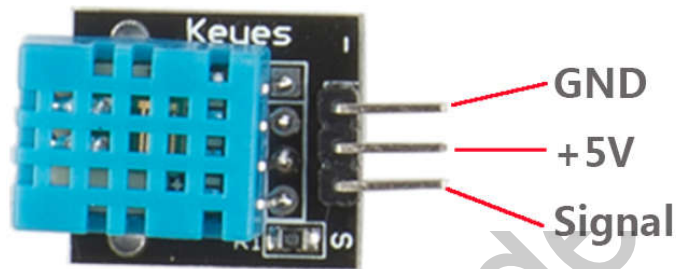

Components

- 1 * SunFounder Uno board
- 1 * USB data cable
- 1 * Humiture sensor module
- 1 * LCD1602
- 1 * Potentiometer
- Jumper wires

Experimental Principle

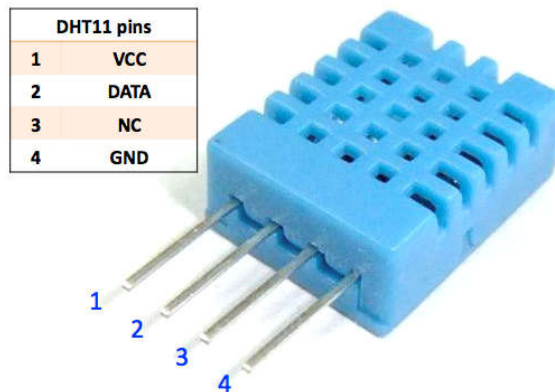

Only three pins are available for use: VCC, GND, and DATA. The communication process begins with the DATA line sending start signals to DHT11, and DHT11 receives the signals and

returns an answer signal. Then the host receives the answer signal and begins to receive 40-bit humidity data (8-bit humidity integer + 8-bit humidity decimal + 8-bit temperature integer + 8-bit temperature decimal + 8-bit checksum). For more information, please refer to DHT11 datasheet.

Experimental Procedures

Step 1: Build the circuit

Humiture Sensor Module	SunFounder Uno
S -----	D4
- -----	GND
+ -----	5V

LCD1602 connection: connect pin RS to digital pin 5; R/W to GND; E to digital pin 6; D4~D7 to digital pin 9 to 12; VSS to GND; VDD to 5V; A to 3.3V; K to GND

Potentiometer connection: Connect the middle pin to VO of LCD1602 and any other pin to GND

Step 2: Program (Please refer to the example code in [LEARN -> Get Tutorial](#) on our [website](#))

Step 3: Compile

Step 4: Upload the sketch to SunFounder Uno

Now, you can see the value of the current humidity and temperature displayed on the LCD.

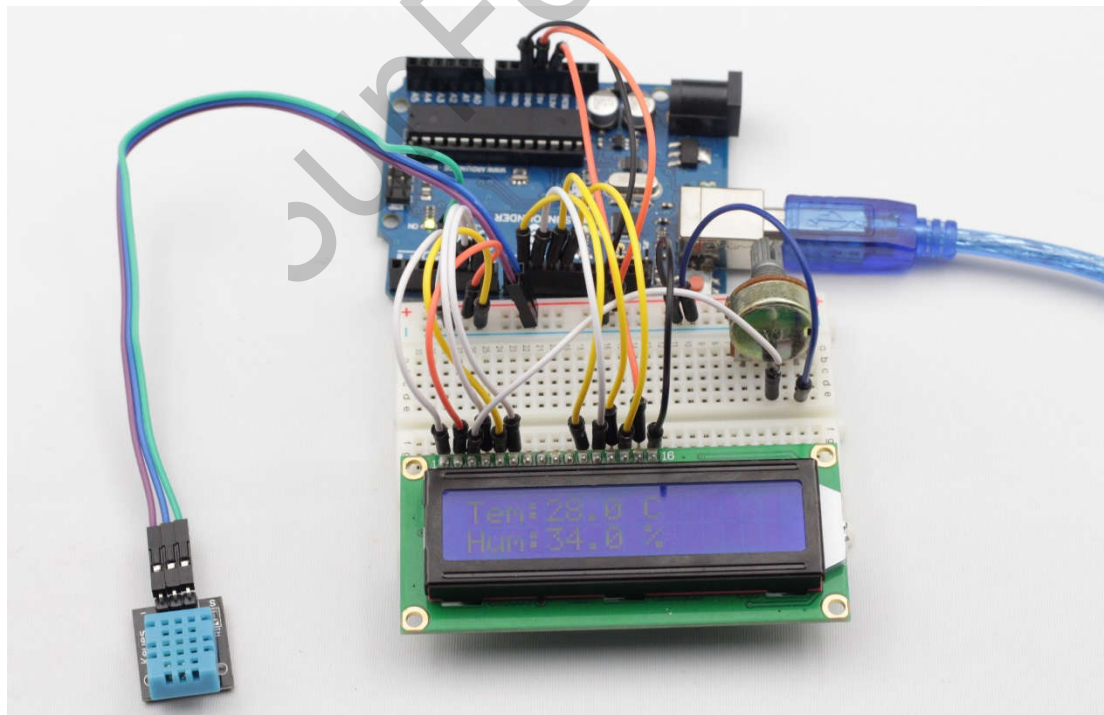

Lesson 23 Obstacle Avoidance Sensor

Introduction

An Obstacle Avoidance Sensor (as shown below) uses infrared reflection principle to detect obstacles. When there is no object in front, infrared-receiver cannot receive signals; when there is an object in front, it will block and reflect infrared light, then infrared-receiver can receive signals.

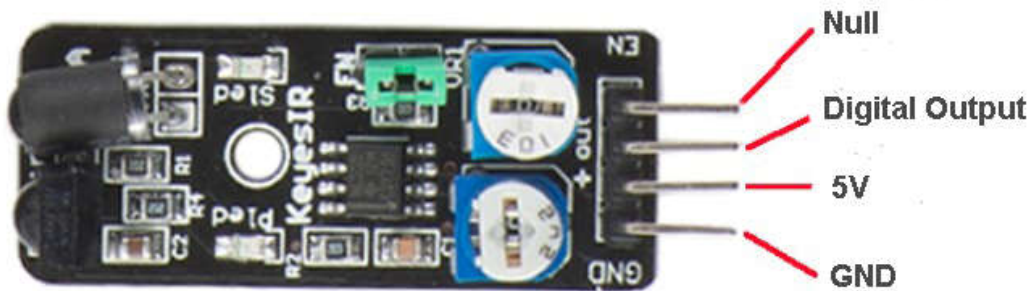

Components

- 1 * SunFounder Uno board
- 1 * USB data cable
- 1 * Obstacle Avoidance Sensor module
- Several jumper wires

Experimental Principle

An obstacle avoidance sensor mainly consists of an infrared-transmitter, an infrared-receiver and a potentiometer. According to the reflecting character of an object, if there is no obstacle, emitted infrared ray will weaken with the propagation distance and finally disappear. If there is an obstacle, when infrared ray encounters an obstacle, it will be reflected back to the infrared-receiver. Then the infrared-receiver detects this signal and confirms an obstacle exists in front.

In this experiment, we will use an obstacle avoidance sensor module and an LED attached to pin 13 of the SunFounder board to build a simple circuit. With the LED attached to pin 13, connect pin OUT to D8 of the SunFounder board. When the obstacle avoidance sensor detects an obstacle, the LED will be on. Otherwise, it will be off.

Note: The obstacle avoidance distance of infrared sensor is adjustable; you can adjust the obstacle avoidance distance by adjusting the potentiometer.

Experimental Procedures

Step 1: Build the circuit

Obstacle Avoidance Sensor module	SunFounder Uno
out -----	D8
- -----	GND
+ -----	5V

Step 2: Program (Please refer to the example code in [LEARN -> Get Tutorial](#) on our [website](#))

Step 3: Compile

Step 4: Upload the sketch to SunFounder Uno

Now, put an obstacle in front of the Obstacle Avoidance Sensor and the LED attached to pin 13 on the SunFounder Uno board will light up.

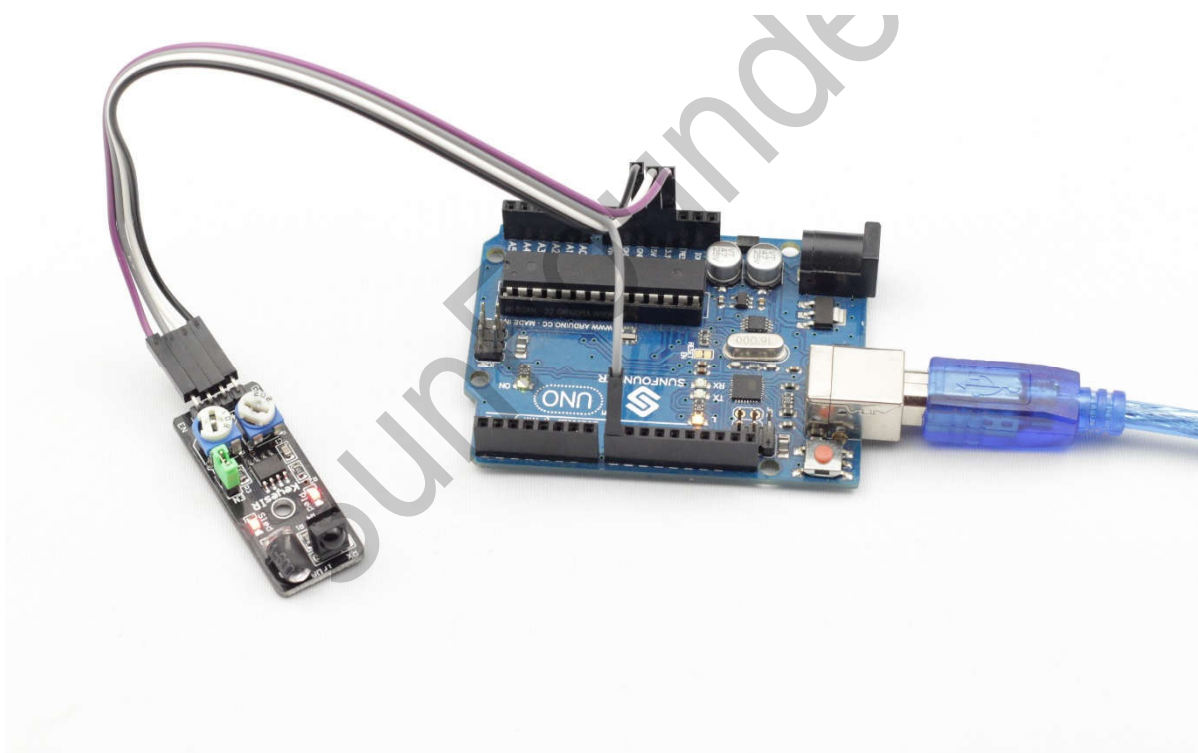

Lesson 24 Tracking Sensor

Introduction

A tracking sensor (as shown below) has the same principle with an obstacle avoidance sensor but has small transmitting power.

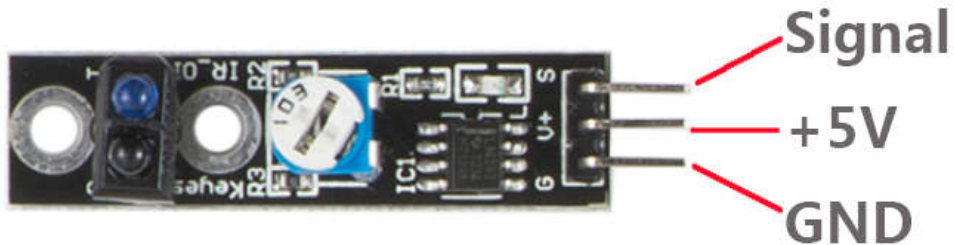

Components

- 1 * SunFounder Uno board
- 1 * USB data cable
- 1 * Tracking sensor module
- Several jumper wires

Experimental Principle

When the infrared transmitter emits rays to a piece of paper, if the rays shine on a white surface, they will be reflected and received by the receiver, and pin S will output low level; If the rays encounter black lines, they will be absorbed, thus the receiver gets nothing, and pin S will output high level.

In this experiment, we will use an obstacle avoidance sensor module and an LED attached to pin 13 of the SunFounder Uno board to build a simple circuit to make a tracking light.

Since an LED has been attached to pin 13, connect the pin out to D8 of the SunFounder Uno board. When the tracking sensor detects reflection signals (white), the LED will be on. Otherwise, it will be off (black line).

Experimental Procedures

Step 1: Build the circuit

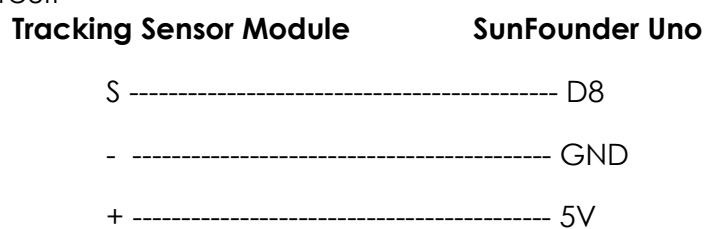

Step 2: Program (Please refer to the example code in [LEARN -> Get Tutorial](#) on our [website](#))

Step 3: Compile

Step 4: Upload the sketch to SunFounder Uno

Now, draw two black thick lines on the paper. If the rays emitted by the sensor encounter the black lines, the LED attached to pin 13 on SunFounder Uno board will light up. Otherwise, it will go out.

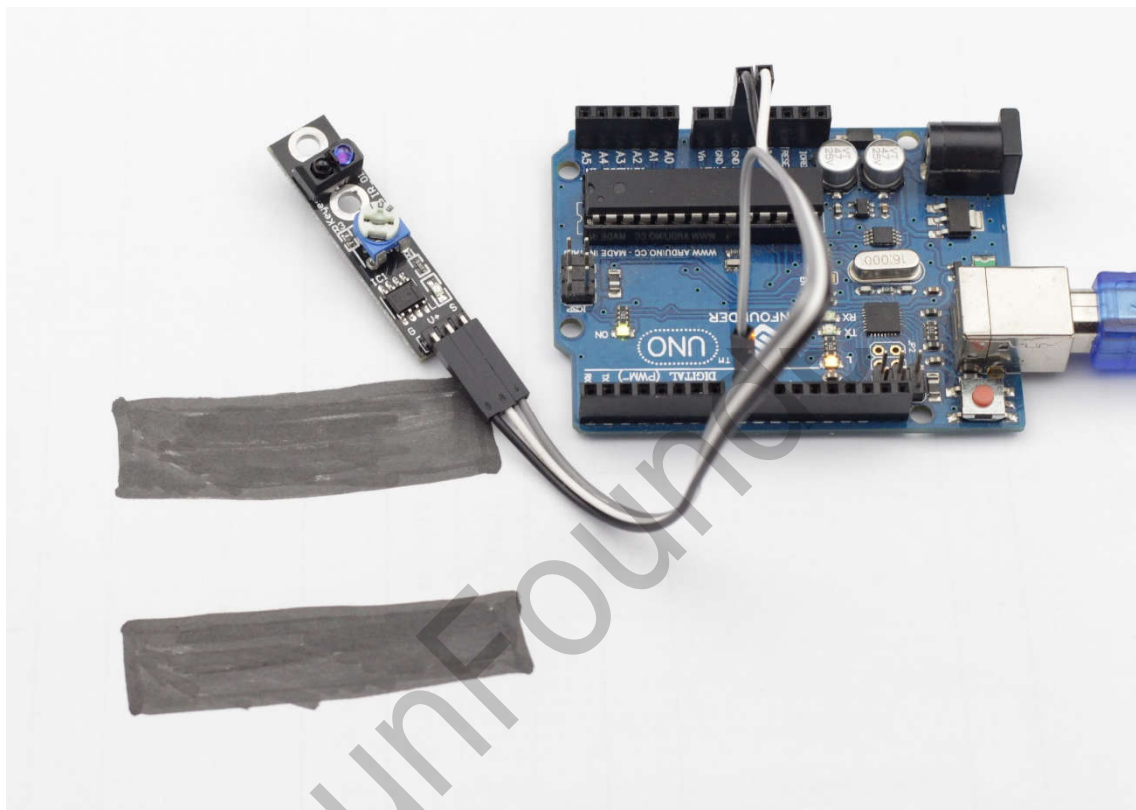

Lesson 25 Microphone Sensor

Introduction

There are two kinds of microphone sensor in this kit: microphone sensor and high-sensitive voice sensor (as shown below). The only difference between them is sensitivity. In this experiment, we will take the microphone sensor for example. You may try to apply the other sensor based on what you've got during the process.

Both sensors have two outputs:

AO: analog output, to output voltage signals from microphone in a real-time manner

DO: When sound intensity reaches a certain threshold, the sensor outputs high or low level (you can adjust the threshold by potentiometer)

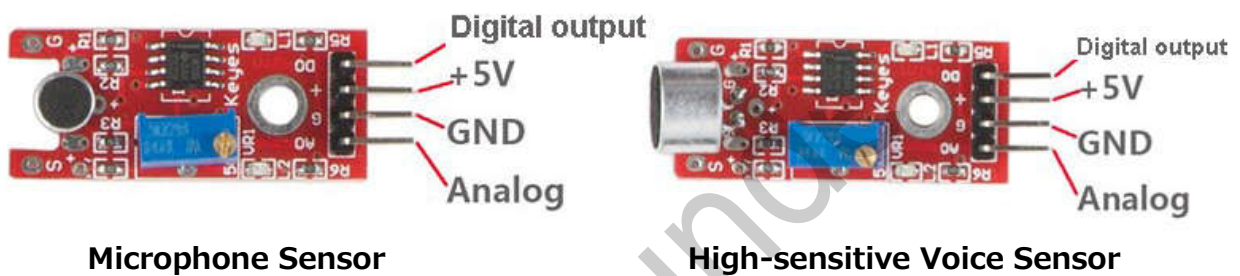

Components

- 1 * SunFounder Uno board
- 1 * Breadboard
- 1 * USB data cable
- 1 * Microphone sensor module
- Several jumper wires

Experimental Principle

Microphone can convert audio signal into electrical signal (analog quantity), then convert analog quantity into digital value by ADC and transfer it to MCU to process.

The schematic diagram:

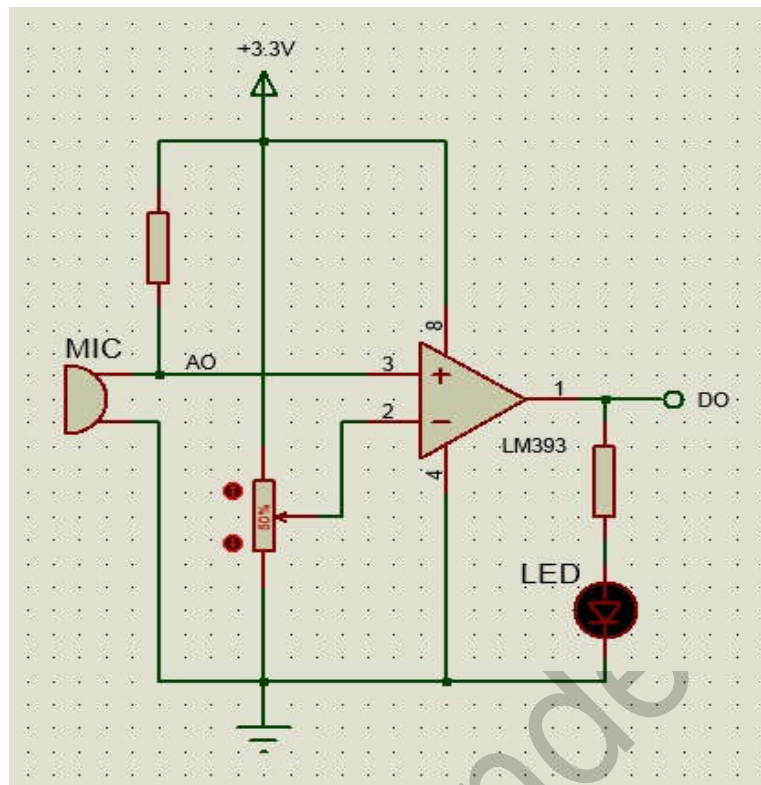

LM393 is a voltage comparator. When the voltage of the in-phase terminal (pin 3) is higher than that of the inverting terminal (pin 2), the output terminal (pin 1) will output high. Otherwise, it outputs low. First, adjust the potentiometer to make the voltage for pin 2 of LM393 less than 5V. When there is no voice input, the resistance of the microphone is very large. The voltage for pin 3 of LM393 is close to power supply voltage (5V), pin 1 outputs high and the LED is on; when there is voice input, the resistance of the microphone decreases, pin 1 outputs low and the LED is off. And connect pin 1 to IO of the SunFounder Uno board to detect sounds by programming.

Experimental Procedures

Step 1: Build the circuit

Microphone Sensor Module

SunFounder Uno

AO ----- A0
 G ----- GND
 + ----- 5V
 DO ----- D8

Step 2: Program (Please refer to the example code in [LEARN -> Get Tutorial](#) on our [website](#))

Step 3: Compile

Step 4: Upload the sketch to SunFounder Uno

Now, speak near or blow into the microphone, and you can see the LED attached to pin 13 on the SunFounder Uno board brighten.



Lesson 26 Metal Touch Sensor

Introduction

A metal touch sensor is a type of switch that only operates when it's touched by a charged body. It has a high-frequency transistor which can conduct electricity when receiving electromagnetic signals.

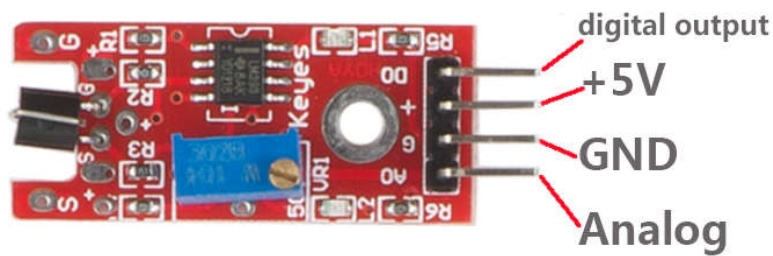

Components

- 1 * SunFounder Uno board
- 1 * USB data cable
- 1 * Metal touch sensor module
- Several jumper wires

Experimental Principle

In this experiment, touch the base electrode of a transistor with fingers to make it conduct electricity, for human body itself is a kind of conductor and an antenna that can receive electromagnetic waves in the air. These electromagnetic wave signals collected by human body are amplified by the transistor and processed by the comparator on the module to output steady signals.

With the LED attached to pin 13 of Uno, connect pin D0 of the sensor to D7 of the Uno board. When the metal touch sensor detects touch signals, the LED will be on. Otherwise, it will be off.

Experimental Procedures

Step 1: Build the circuit

Metal Touch Sensor	SunFounder Uno
AO -----	A0
G -----	GND
+ -----	5V
D0 -----	D7

Step 2: Program (Please refer to the example code in [LEARN -> Get Tutorial](#) on our [website](#))

Step 3: Compile

Step 4: Upload the sketch to SunFounder Uno

Now, touch the base electrode of the transistor and the LED attached to pin 13 on the SunFounder Uno board will light up.

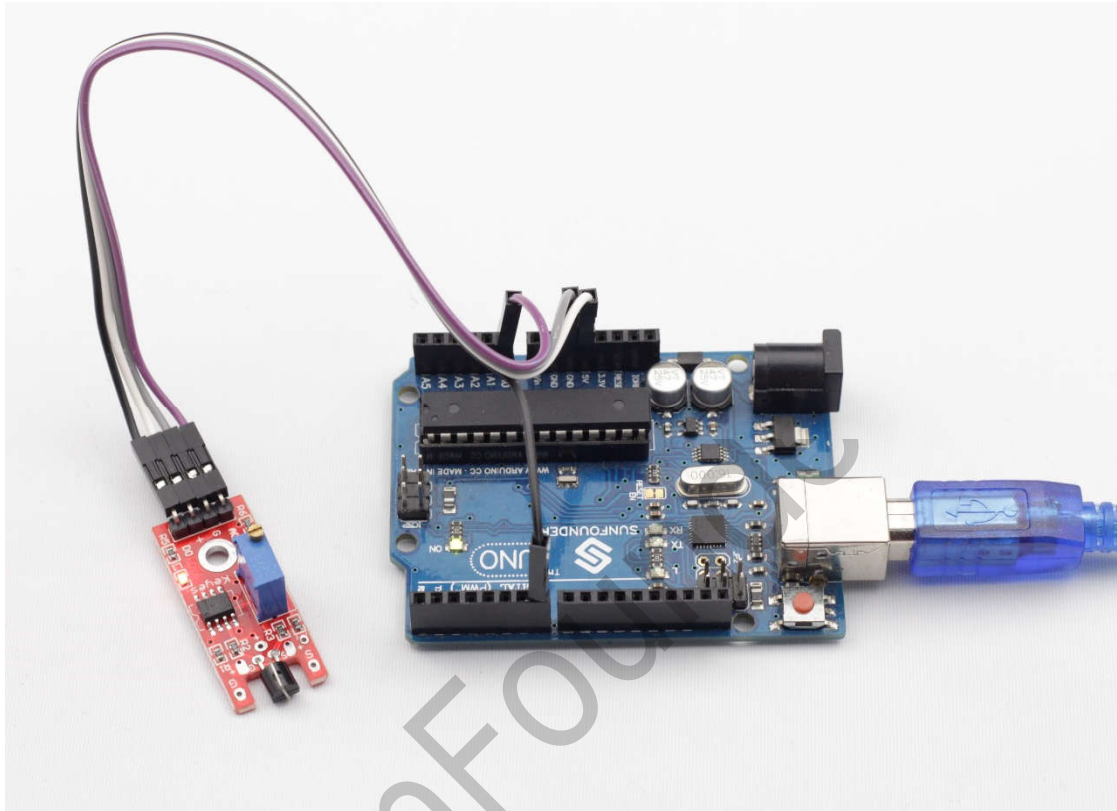

Lesson 27 Flame Sensor

Introduction

A flame sensor module performs detection by capturing infrared wavelengths from flame. It can be used to detect and warn of flames.

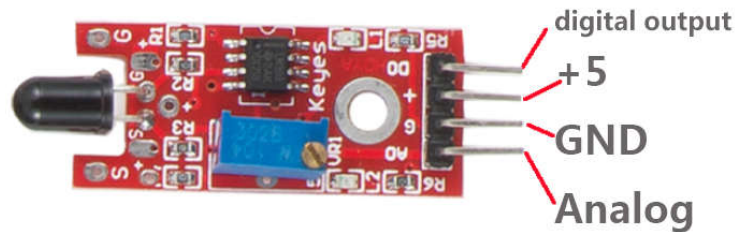

Components

- 1 * SunFounder Uno board
- 1 * USB data cable
- 1 * Flame sensor module
- Several jumper wires

Experimental Principle

There are several types of flame sensors. In this experiment, we will use a far-infrared flame sensor. It can detect infrared light with a wavelength ranging from 700nm to 1000nm. A far-infrared flame probe converts the strength changes of the external infrared light into current changes. And then it converts analog quantities into digital ones.

In this experiment, connect pin D0 to D8 of the SunFounder Uno board. When the flame sensor detects flame signals, the LED attached to pin 13 of the Uno board will brighten. Otherwise, it will keep off.

Experimental Procedures

Step 1: Build the circuit

Flame Module	SunFounder Uno
AO -----	A0
G -----	GND
+ -----	5V
DO -----	D8

Step 2: Program (Please refer to the example code in [LEARN -> Get Tutorial](#) on our [website](#))

Step 3: Compile

Step 4: Upload the sketch to SunFounder Uno

Now, ignite a lighter near the flame sensor, and the LED on the module and that attached to pin 13 on Uno will light up.



Lesson 28 Relay Module

Introduction

Relays are suitable for driving high power electronic devices such as lights, electric fans and air condition. A relay can be used to control high voltages with a low voltage by connecting it to an MCU.

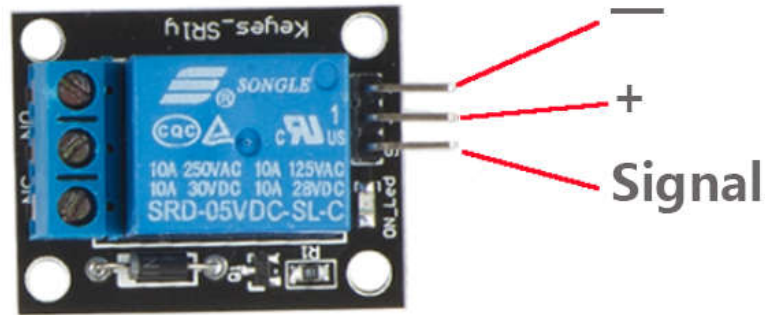

Components

- 1 * SunFounder Uno board
- 1 * USB data cable
- 1 * Relay module
- Several jumper wires

Experimental Principle

Connect IO to the SunFounder Uno board. When we make the transistor output low level (0V) by programming, the transistor will conduct electricity because of current saturation. The normally open contact of the relay will be closed, while the normally closed contact of the relay will be opened; when it outputs high level (5V), the transistor will be cut off, and the relay will restore to the initial state.

Experimental Procedures

Step 1: Build the circuit

Relay module	SunFounder Uno
S	D6
-	GND
+	5V

Step 2: Program (Please refer to the example code in [LEARN -> Get Tutorial](#) on our [website](#))

Step 3: Compile

Step 4: Upload the sketch to SunFounder Uno

Now, you may hear the ticktock. That's the normally closed contact opened and the normally open contact closed. You can attach a high voltage device to the module. For example, connect a bulb of 220V voltage to the output port of the relay module, and then the relay will act as an automatic switch.

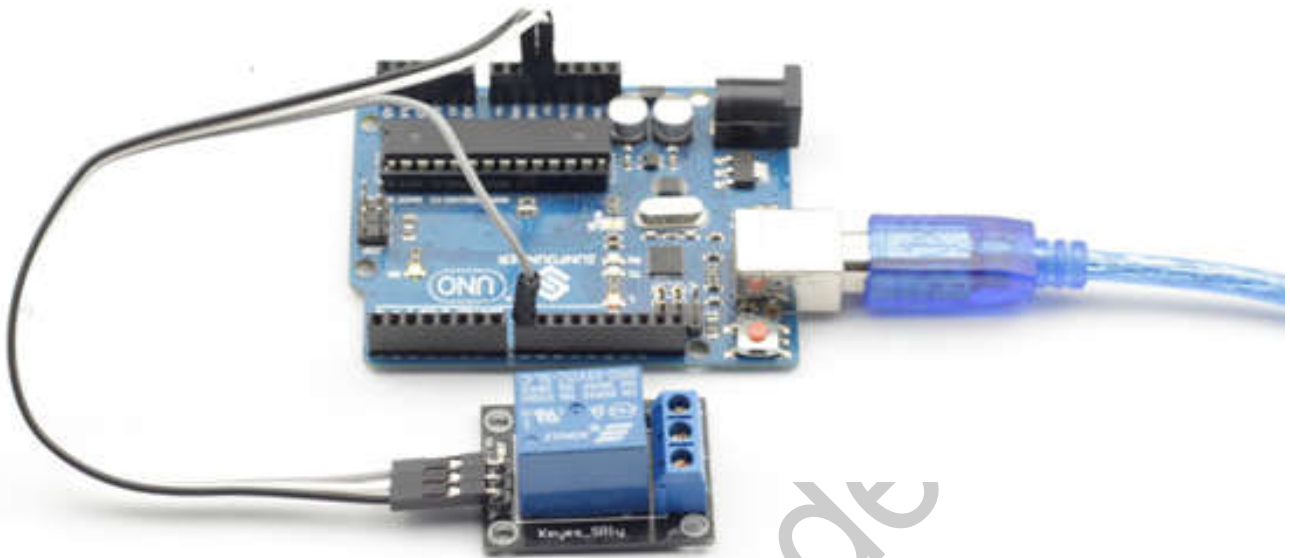

Lesson 29 Joystick PS2

Introduction

A joystick is an input device consisting of a stick that pivots on a base and reports its angle or direction to the device it is controlling. Joysticks are often used to control video games and robots. A Joystick PS2 is used here.

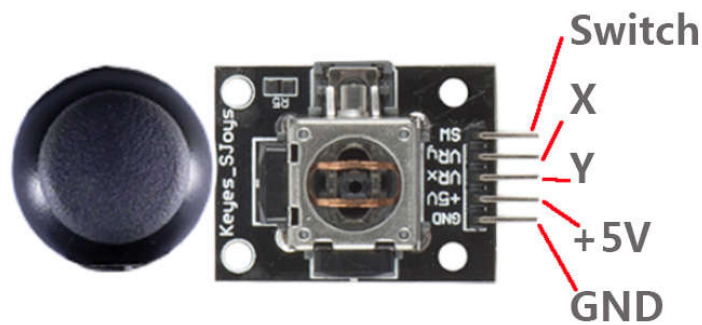

Components

- 1 * SunFounder Uno board
- 1 * USB data cable
- 1 * Joystick PS2 module
- Several jumper wires

Experimental Principle

This module has two analog outputs (corresponding to X, Y biaxial offsets) and one digital output representing whether it is pressed on Z axis. The module integrates power indicator and can display operation condition.

In this experiment, we use the SunFounder Uno board to detect the moving direction of the Joystick knob and pressing of the button.

Experimental Procedures

Step 1: Build the circuit

Joystick PS2 Module	SunFounder Uno
SW -----	D8
VRx -----	A0
VRy -----	A1
+5V -----	5V
GND -----	GND

Step 2: Program (Please refer to the example code in [LEARN -> Get Tutorial](#) on our [website](#))

Step 3: Compile

Step 4: Upload the sketch to SunFounder Uno

Now, push the rocker and the coordinates of X and Y axes displayed on Serial Monitor will change accordingly; press the button, and the coordinate of Z=0 will also be displayed.

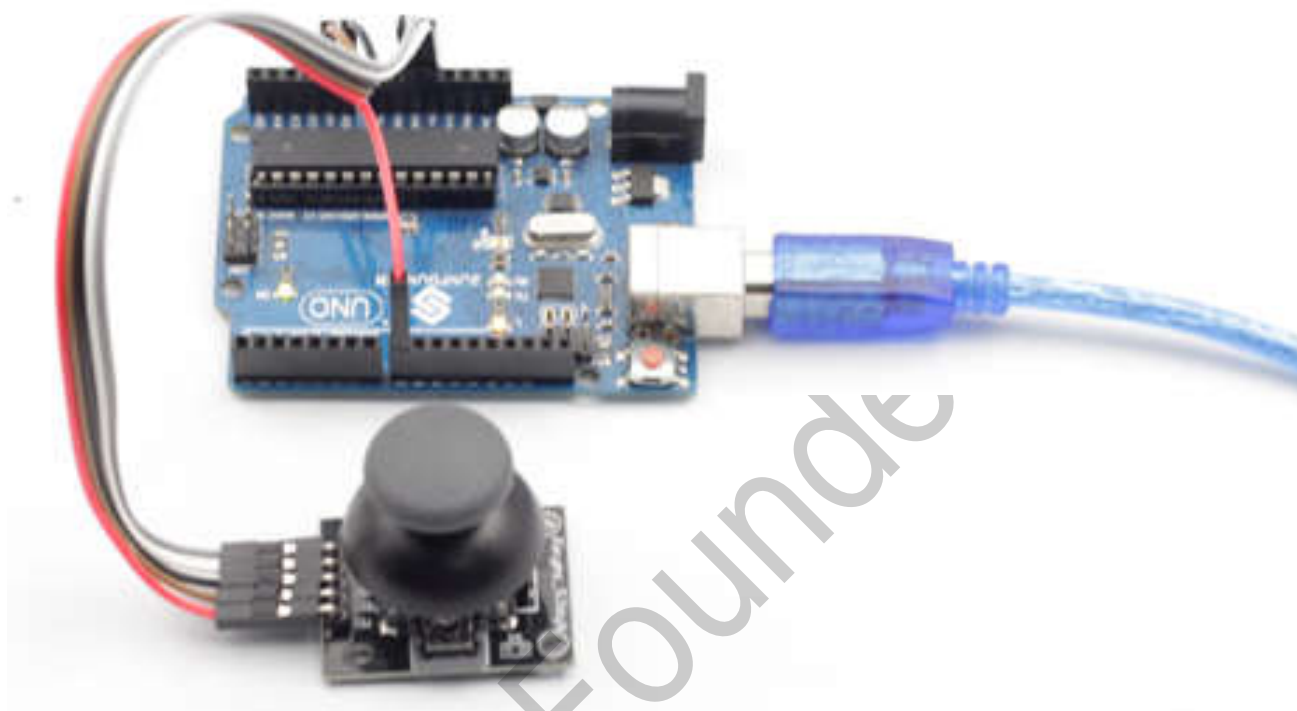

Lesson 30 MQ-2 Gas Sensor

Introduction

Gas Sensor MQ-2 is for flammable gas and smoke detection by measuring concentrations of combustible gases in the air. They are often used for detecting smoke and flammable gasses in households, industry or automobiles.

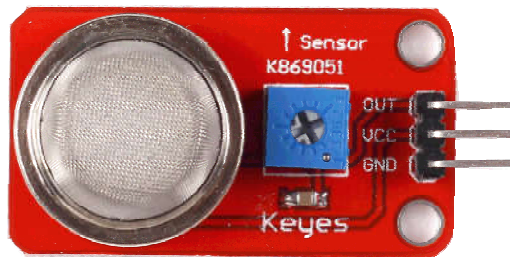

Components

- 1 * SunFounder Uno board
- 1 * USB data cable
- 1 * MQ-2 Gas sensor module
- Several jumper wires

Experimental Principle

MQ-2 gas sensor applies SnO₂ (an oxygen-deficient n-type semiconductor) which has a lower conductivity in the clear air as a gas-sensing material. In an atmosphere where there may be inflammable gases, the conductivity of the gas sensor raises along with the inflammable gas concentration increases. MQ-2 performs a good detection to different inflammable gases such as natural gas, especially sensitive to liquefied gas, propane and hydrogen. The higher the concentration is, the greater the conductivity will be, thus changing the output signal.

In this experiment, release a small amount of smoke or flammable gas around the sensor and watch the value at A0 increase. Once the concentration of the gas exceeds a limit, the LED attached to pin 13 of Uno will light up.

Experimental Procedures

Step 1: Build the circuit

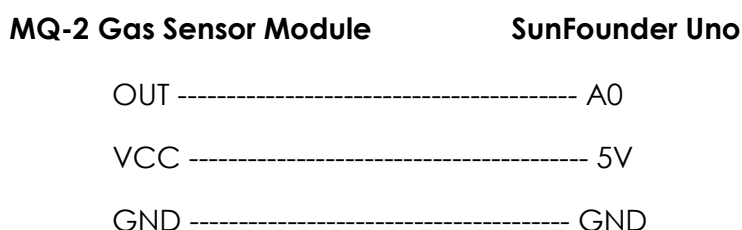

Step 2: Program (Please refer to the example code in [LEARN -> Get Tutorial](#) on our [website](#))

Step 3: Compile

Step 4: Upload the sketch to SunFounder Uno

Now, ignite a lighter or light a candle and release a small amount of smoke or gases into a flask (or other glass containers). Then place the sensor over the container, or invert the container and place the sensor at the mouth. When the concentration reaches the threshold, you can see the value displayed on Serial Monitor change.

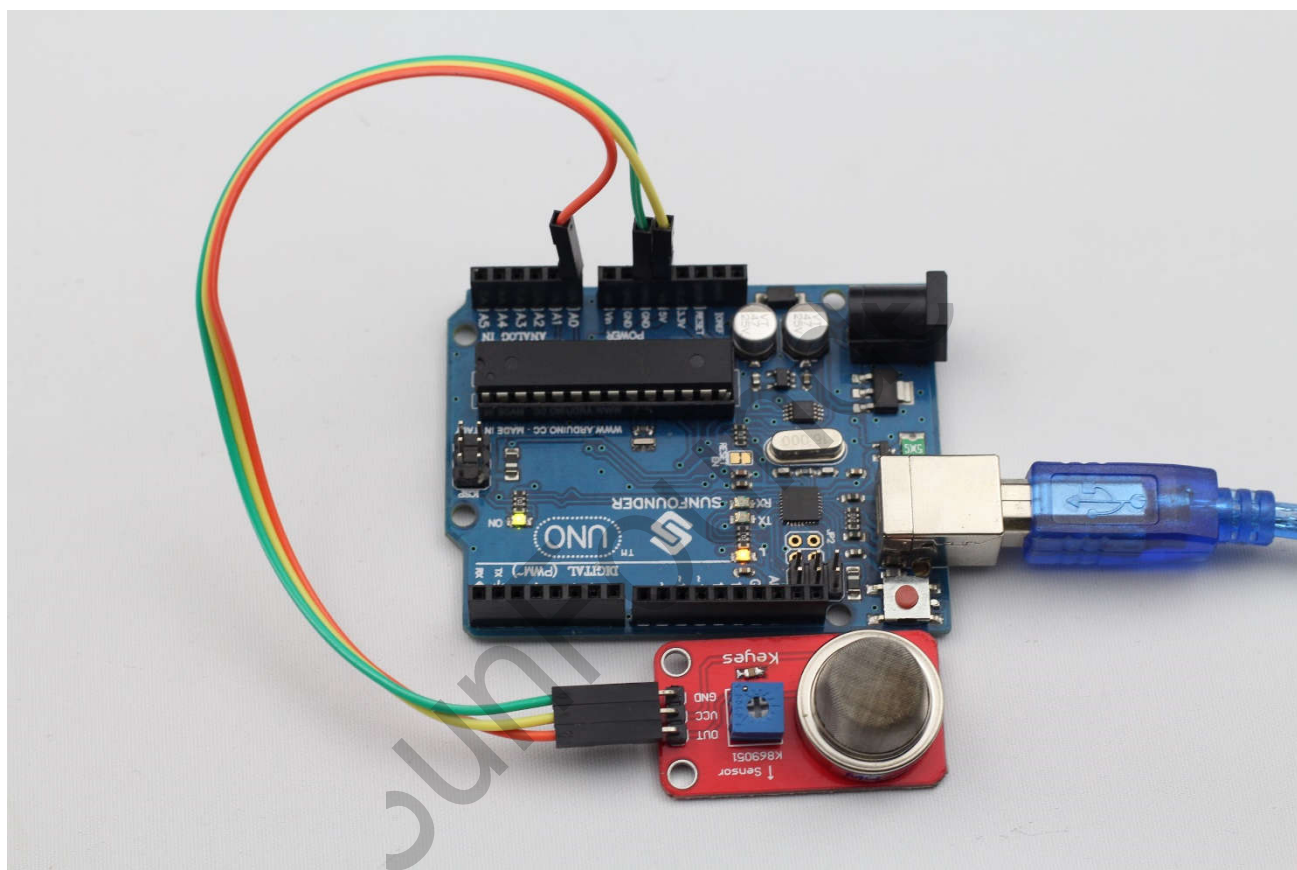

Lesson 31 Password Lock

Introduction

After having learnt so many independent modules, let's use several together to make some comprehensive experiments. In this lesson, we use an LCD1602, a relay module, a potentiometer and a keypad to assemble a simple password lock. The circuit is controlled by the SunFounder Uno board and can be applied in security door. Let's get started!

Components

- 1 * SunFounder Uno board
- 1 * USB data cable
- 1 * Relay module
- 1 * LCD1602
- 1 * Keypad
- 1 * Potentiometer
- Several jumper wires

Experimental Principle

After the circuit and code are completed, first set a password (for example, 123456) with the SunFounder Uno. Then input the password by the keypad. If this password is consistent with what was set, the relay will be closed and the LED attached to pin 13 of the Uno will light up. Otherwise, the relay will keep opened and the LED will be off.

Experimental Procedures

Step 1: Build the circuit

Relay connection: Connect pin S to pin 13 on the SunFounder board, pin - to GND, + to 5V

LCD1602 connection: Connect pin RS to D0; R/W to GND; E to D1; D4~D7 to D2, D3, D4, and D12; VSS to GND; VDD to 5V; A to 3.3V; K to GND

Potentiometer connection: Connect the middle pin to VO of LCD1602 and any other pin to GND

Keypad connection: Connect row 1, 2, 3 and 4 to D11, D10, D9, and D8; connect column 1, 2, and 3 to D7, D6, and D5 (see the following figure for pins connected to columns and rows)

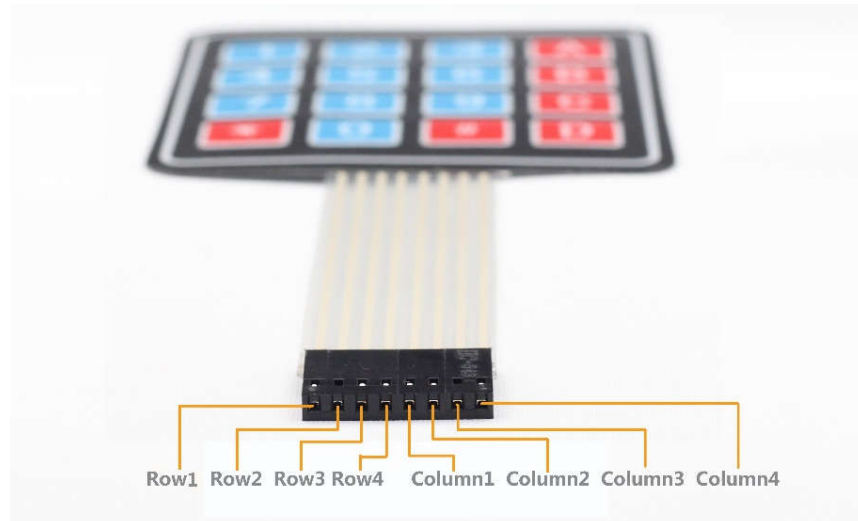

Step 2: Program (Please refer to the example code in [LEARN -> Get Tutorial](#) on our [website](#))

Step 3: Compile

Step 4: Upload the sketch to SunFounder Uno

Now, the LCD will show **"Welcome"** after power on. When you press the * key, it will prompt **"Input Your Code:"**. If you input 123456 and press # key to confirm, **"Input Correctly Please Come In"** will be displayed and the LED will light up. If you input other contents, the message **"Input Error Please Again"** will be shown and the LED will be off.

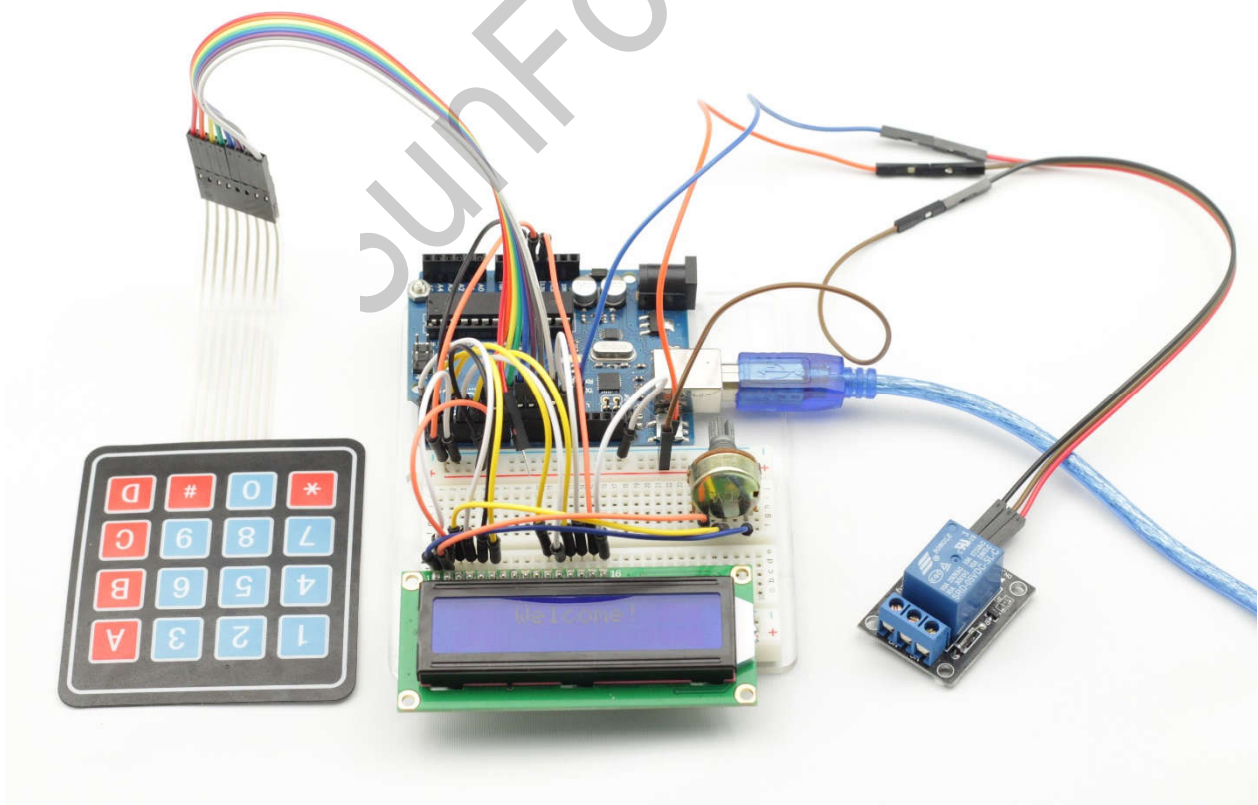

Lesson 32 Lie Detector

Introduction

How can an Evil Genius be sure that their prisoners are telling the truth? By a lie detector, of course. This lie detector uses an effect known as galvanic skin response. As a person becomes nervous – for example, when telling a lie – their skin resistance decreases. We can measure this resistance using an analog input and use an LED and buzzer to indicate an untruth. Use a multicolor LED that can display red to indicate a lie, green to indicate the truth, and blue to show that the lie detector should be adjusted by the variable resistor.

Components

- 1 * SunFounder Uno board
- 1 * USB data cable
- 1 * RGB module
- 1 * Buzzer module
- 1 * Potentiometer (250k)
- 1 * Resistor (470k)
- Several jumper wires

Experimental Principle

The subject's skin resistance is measured by using the test subject as a resistor in a potential divider and a fixed resistor as the other. The lower their resistance is, the more analog input 0 will be pulled towards 5V. The higher the resistance gets, the closer to GND it will become.

The buzzer, despite of the noise level these things generate, is actually quite low in current consumption and can be driven directly from the SunFounder Uno digital pin. This experiment uses an RGB LED. In this case, however, we are not going to make it flash mixed colors but just turn one of the LEDs on at a time to display red, green, or blue.

Experimental Procedures

Step 1: Build the circuit

RGB Connection: Connect pin R to digital pin 9, G to digital pin 10, B to digital pin 11, and pin - to GND

Buzzer Connection: Connect pin S to digital pin 8, + to 5V, and pin - to GND

Potentiometer Connection: Connect the middle pin to analog port A1, and the other two pins to GND and 5V

Resistor Connection: connect one terminal to analog port A0, and the other to GND

Then, take out two jumper wires, and connect one end of one jumper wire to A0 and one end of the other wire to 5V.

Step 2: Program (Please refer to the example code in [LEARN -> Get Tutorial](#) on our [website](#))

Step 3: Compile

Step 4: Upload the sketch to SunFounder Uno

To test the lie detector, you might need a test subject, as you will need one hand free to adjust the knob of the potentiometer.

Now ask your test subject to side down. First, let him/her touch the other end of the two jumper wires with two adjoining fingers. Then spin the knob of the pot until the LED turns green.

You may now "interrogate" the subject. If he/she lies to your questions, the LED will flash red and the buzzer beeps. If the LED flashes either red or blue, you should adjust the knob until it changes to green again. Then continue the interrogation.

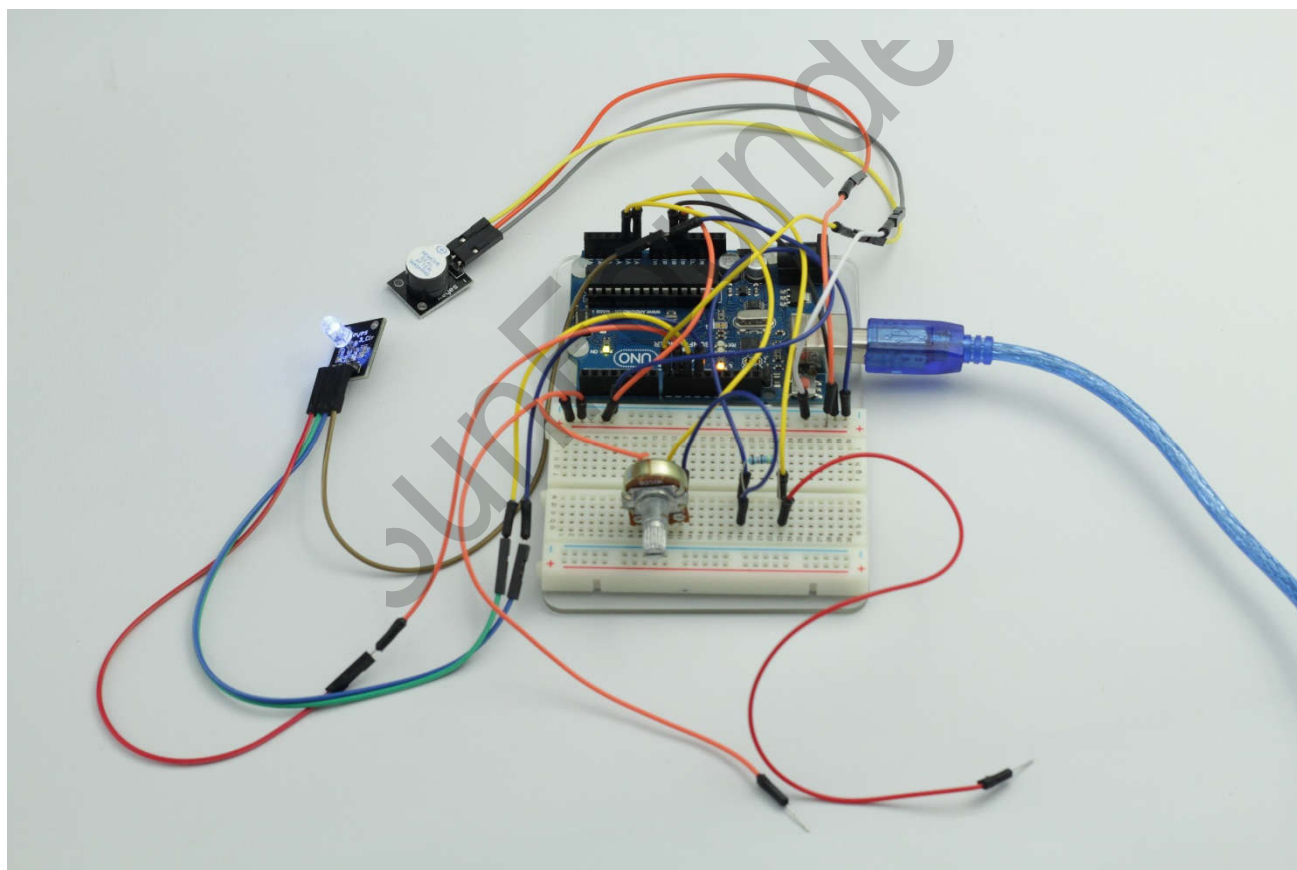

Lesson 33 Fire Alarm

Introduction

With the increasing use of fire and electricity in household, home fire accidents occur more and more frequently. Thus, fire alert plays a more important role in people's life. In this lesson, we will use a gas sensor, a flame sensor and a passive buzzer module to assemble a fire alarm.

Components

- 1 * SunFounder Uno board
- 1 * USB data cable
- 1 * MQ-2 Gas sensor module
- 1 * Flame sensor module
- 1 * Passive Buzzer module
- Several jumper wires

Experimental Principle

Gas sensors can detect the concentration of smoke generated to warn of possible fires, when flame sensors can do the infrared rays emitted by fire. Detecting both smoke and flames, we can tell whether a fire's happened. At the same time, the buzzer will beep to warn.

Experimental Procedures

Step 1: Build the circuit

Buzzer Connection: Connect pin S to D3 of Uno

MQ-2 Gas Sensor Connection: Connect pin OUT to A1, VCC to 5V, and GND to GND

Flame Sensor: Connect pin DO to D8, G to GND, and + to 5V

Step 2: Program (Please refer to the example code in [LEARN -> Get Tutorial](#) on our [website](#))

Step 3: Compile

Step 4: Upload the sketch to SunFounder Uno

Now, ignite a lighter near the sensor and you can see the LED attached to pin 13 light up and the buzzer beeps.

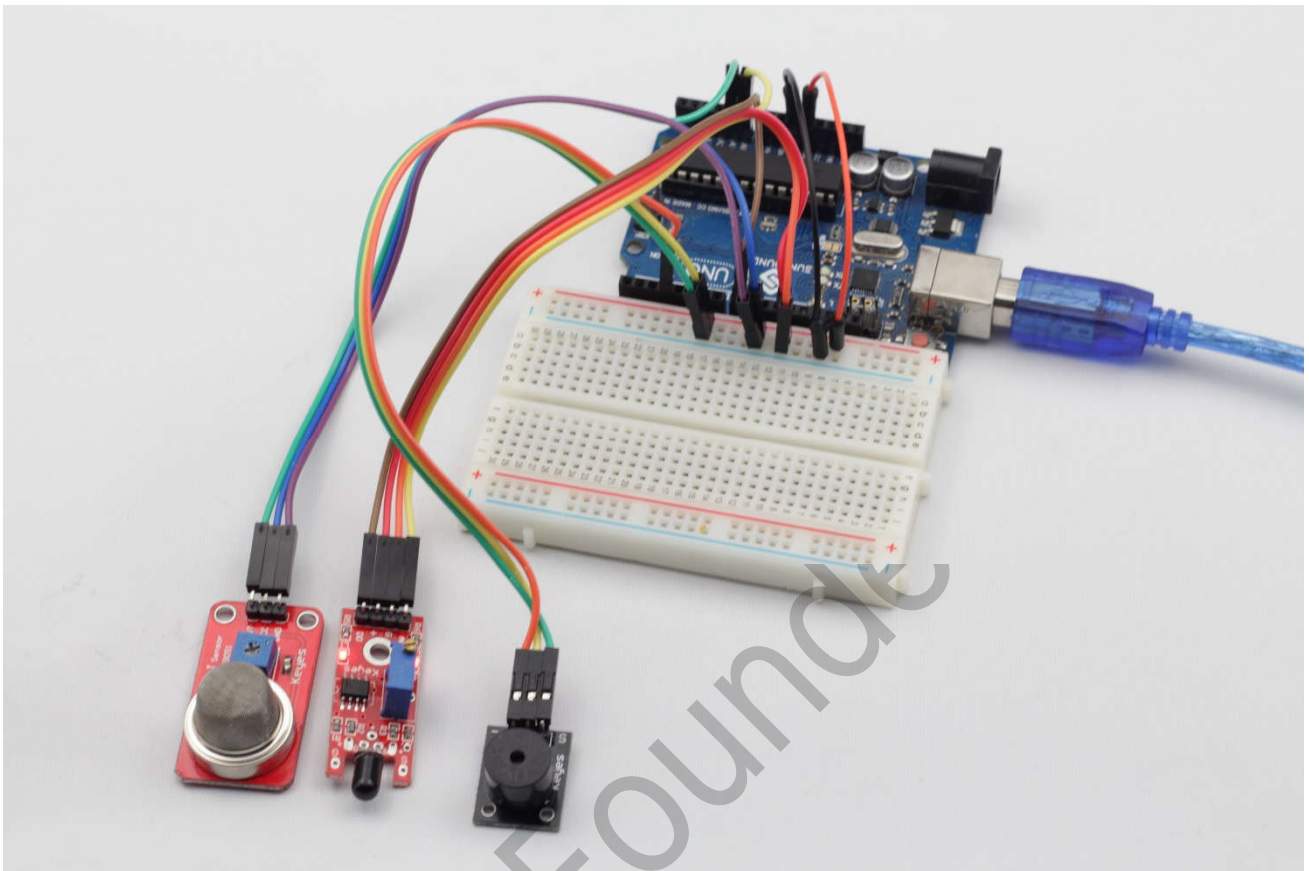

Lesson 34 Thermostatic Water Tank System

Introduction

In this lesson, we will use a Rotary Encoder module, an Analog Temperature Sensor module, a Relay module, a Button module and an I2C LCD1602 to build a Thermostatic Water Tank system. The tank can be used in various situations, such as in the test department of medical organizations and colleges, scientific research, chemical industry, printing and dyeing industry to distil, dry, inspissate and heat chemical medicines and cultivate biological products in a constant temperature, as well as to boil and disinfect equipment.

Components

- 1 * SunFounder Uno board
- 1 * USB data cable
- 1 * Rotary Encoder module
- 1 * Analog Temperature Sensor module
- 1 * LCD1602
- 1 * Relay module
- 1 * Button module
- Several jumper wires

Experimental Principle

In this experiment, we use a thermistor temperature sensor and an LCD to sense and display both the current temperature and the set temperature. A rotary encoder is used to change the set temperature. When the measured temperature value is lower than the set value, the relay is activated. Relays are old-fashioned electromagnetic components that activate a mechanical switch when a current flows through its coil of wire. They can switch high currents and voltages, making them suitable for controlling main equipment.

Experimental Procedures

Step 1: Build the circuit

LCD1602 Connection: connect pin RS to digital pin 12; R/W to GND; E to digital pin 11; D4~D7 to digital pin 10, 9, 8, and 7; VSS to GND; VDD to 5V; A to 3.3V; K to GND

Button Connection: connect pin S to digital pin 5, pin - to GND, and + to 5V

Analog-temperature sensor Connection: connect pin S to analog port A0, - to GND, and + to 5V

Relay Connection: connect pin S to digital pin 6, pin - to GND, and + to 5V

Rotary Encoder Connection: connect pin CLK to digital pin 2, DT to digital pin 3, SW to digital pin 4, pin - to GND, and + to 5V

Step 2: Program (Please refer to the example code in [LEARN -> Get Tutorial](#) on our [website](#))

Step 3: Compile

Step 4: Upload the sketch to SunFounder Uno

Now, after start up, you will see "**Thermostatic Water Tank**" displayed on the LCD1602, and then current temperature in both Celsius and Fahrenheit degrees. Press the button to setup.

Then spin the knob of the rotary encoder to change the temperature threshold. After setting is finished, for example, to 30°C, press the rotary encoder to confirm. Touch the thermistor and the value displayed on the LCD varies and finally the LED on the SunFounder Uno board will dim, for the measured temperature is higher than the threshold.

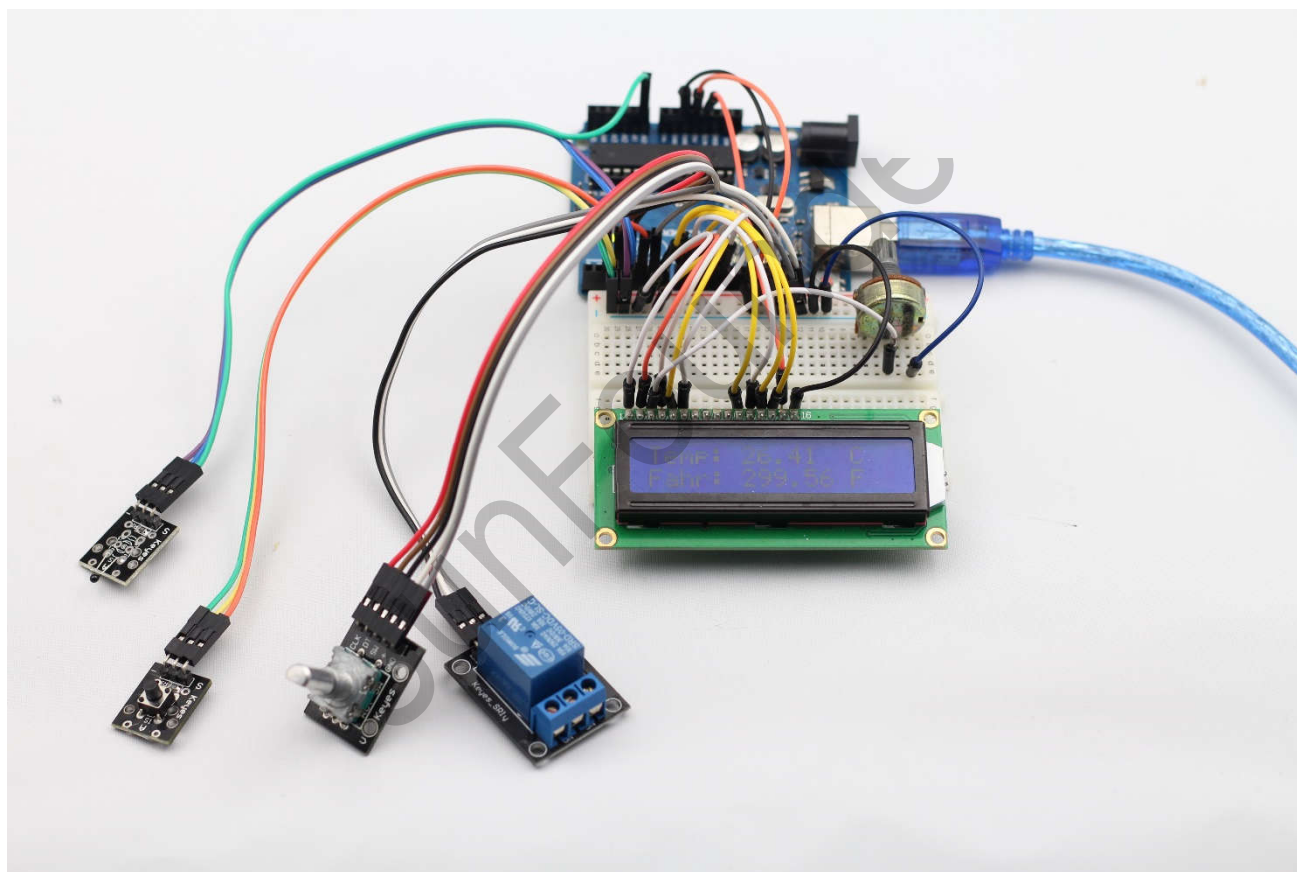

Lesson 35 Intelligent Environment Monitoring

Introduction

In this lesson, we will use a humidity sensor module, a DS18B20 module, an infrared receiver module, a high-sensitive voice sensor module, a photoresistor module, an analog-hall sensor module, an LCD1602 and a remote control to build an intelligent environment monitoring system.

Components

- 1 * SunFounder Uno board
- 1 * USB data cable
- 1 * DHT11 Humiture Sensor module
- 1 * DS18B20 module
- 1 * Infrared Receiver module
- 1 * Remote Control
- 1 * High-sensitive Voice Sensor module
- 1 * Photoresistor module
- 1 * Analog Hall Sensor module
- 1 * LCD1602
- Several jumper wires

Experimental Principle

After power on, when you press the **Power** key, "**Environment Monitor Begin:**" will be displayed on the LCD. Press digital 1 key and it will display "**DS18B20**" and the current temperature; press digital 2 key and it will display "**DHT11**" and the current humidity; press digital 3 key and it will display "**Big Sound**" and the current sound level; press digital 4 key and it will display "**Light Sensor**" and the current light intensity; press digital 5 key and it will display "**Analog Hall**" and the current magnetic field intensity; if you press digital 6 key, the display will exit and stop.

Experimental Procedures

Step 1: Build the circuit

LCD1602 Connection: connect pin RS to D12; R/W to GND; E to D11; D4~D7 to D10, D9, D8, and D7; VSS to GND; VDD to 5V; A to 3.3V; K to GND

Infrared Receiver module connection: connect pin S to D3, pin - to GND, and + to 5V

DS18B20 module connection: connect pin S to D2, pin - to GND, and + to 5V

DHT11 Humiture Sensor module connection: connect pin S to D4, pin - to GND, and + to 5V

High-sensitive Voice Sensor module connection: connect pin A0 to analog port A0, pin - to GND, and + to 5V

Photoresistor module connection: connect pin S to analog port A1, pin - to GND, and + to 5V

Analog-hall sensor module connection: connect pin S to analog port A2, pin - to GND, and + to 5V

Step 2: Program (Please refer to the example code in [LEARN -> Get Tutorial](#) on our [website](#))

Step 3: Compile

Step 4: Upload the sketch to SunFounder Uno

Now, press "**Power**" Key and you can see "**Environment Monitor Begin:**" on the LCD.

Press digital 1 key and it will show "**DS18B20**" and a temperature value.

Press digital 2 key – "**DHT11**" and current humidity.

Press digital 3 key – "**Big Sound**" and current sound level.

Press digital 4 key – "**Light Sensor**" and current light intensity.

Press digital 5 key – "**Analog Hall**" and the current magnetic field intensity.

Press digital 6 key and the display will exit and restore to null.

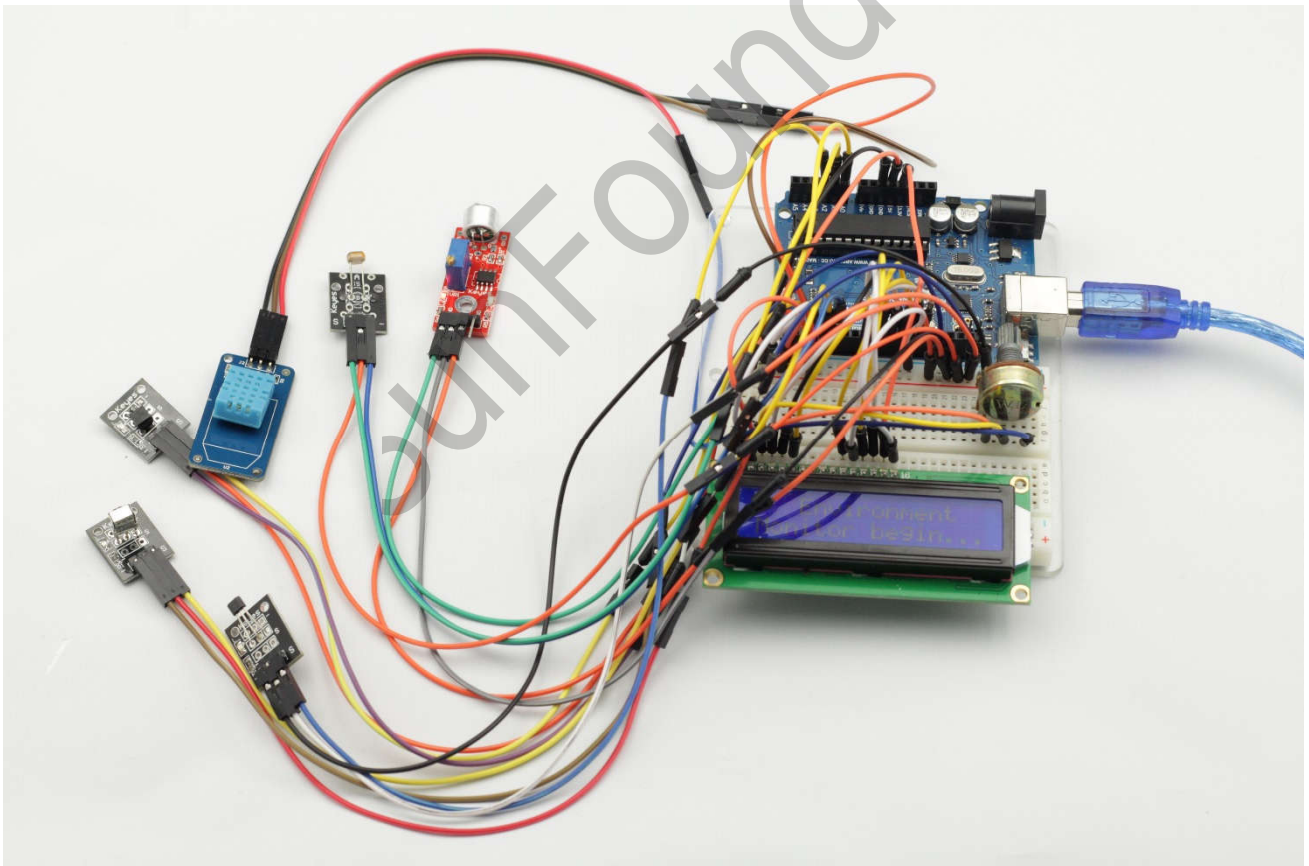

For Safe Use

All parts and devices in this kit should be powered appropriately in compliance with relevant regulations and standards applicable in the country of intended use.

The connection of unapproved external devices to the modules/boards in this kit may affect compliance or result in damage to the unit, for which we will not be responsible.

To avoid malfunction or damage to your circuit boards, please observe the following:

DO NOT expose it to water/moisture or place it on a conductive surface whilst in operation.

DO NOT expose it to heat from any source; the product is designed for reliable operation at normal ambient room temperatures.

Take care whilst handling to avoid mechanical or electrical damage to the printed circuit board and connectors.

PLEASE perform the connection or wiring based on the instructions in the manual or our website if you are not clear of the results.

Copyright Notice

All contents including but not limited to texts, images, and code in this manual are owned by the SunFounder Company. You should only use it for personal study, investigation, enjoyment, or other non-commercial or nonprofit purposes, under the related regulations and copyrights laws, without infringing the legal rights of the author and relevant right holders. For any individual or organization that uses these for commercial profit without permission, the Company reserves the right to take legal action.